

# リープヘル製 オールテレーンクレーン 吊上荷重 400ton

## LTM 1400NX

### クレーン部主仕様

吊上荷重	400ton×2.5m	
メインブーム長さ	14.9~70m	
補助ジブ	固定式	6~42m
	起伏式	12~78m
メインブーム段数	6段	
カウンタウエイト	140/100ton	
第1ウインチ	ラインプル	12.4ton
	巻上速度	0 - 120m/分
	ワイヤー長さ/径	350m/23mm
第2ウインチ	ラインプル	12.4ton
	巻上速度	0 - 120m/分
	ワイヤー長さ/径	700m/23mm
最大地上揚程	メインブーム	70m/14ton
	補助ジブ	102m/3.9ton
旋回速度	0 - 1.2rpm	
起伏速度 (84度まで)	約75秒	
ブーム伸縮速度 (14.9~70m)	約533秒	

### フック仕様

容量 (ton)	シーブ数	ワイヤ最大掛け数	フック重量
300	12	25	3.4 t
125	5	11	1.6 t
80	3	7	1.0 t
37	1	3	0.5 t
12.5	-	1	0.6 t

### エンジン仕様

メーカー名	リープヘル社製
型式	D934LA6 ディーゼル
冷却方式	水冷
シリンダー数	4
出力	245HP 1800rpm
最大トルク	116kg-m 1500rpm
燃料タンク	400 ℓ

### 特徴

#### ■ コントロール

ジョイスティックタイプの操作レバー（自動復帰式のユニバーサルコントローラ）により電気式パイロットコントロールされます。

#### ■ 油圧駆動装置

ウインチ回路には圧力補償付流量調整弁を有し、また、自動出力調整装置付油圧ポンプにより駆動されます。

#### ■ 安全装置および指示計

LICCON(リーコン) 過負荷防止計が装備され、吊上げ総荷重、作業半径、ブーム長さ、揚程及びアウトリガ反力等がデジタルで表示されます。

過巻防止装置、ドラム回転計、過巻出し防止装置、油圧安全弁、油圧システム保護用安全バルブが装備されています。

キャビンが20度までチルトバックします。

**本機は、公道を走行する場合、メインブームを別送として走行しなければなりません。**



## キャリア部主仕様

軸数	6
最高速度	80km/h
総歯数	12
定員	2名
タイヤ	16.00 R25
登坂能力* (低速切替時)	約26.9°
最小回転半径	11.98m

\*登坂時の路面状況により、能力も多少異なります。

## エンジン仕様

メーカー名	リーベヘル社製
型式	D9508A7 ディーゼル・エンジン
冷却方式	水冷
シリンダー数	8
出力	612HP 1900rpm
最大トルク	291kg-m 1500rpm
燃料タンク	約550 ℓ

## 特徴

### ■ トランスミッション

ZF製で、トルクコンバーター及びギンターダーを内蔵しております。前進 12段、後進 2段となっており、「TC-TRONIC」自動制御システムを採用しています。

### ■ サスペンション

全軸 hidroニューマチックサスペンションであり、自動水平復帰機能 (ニボー) を有しています。状況に応じて車高を上下に調整可能です。全軸油圧サスペンションをロックすることが可能です。

### ■ ステアリング

油圧源として1つは通常時、エンジンで駆動され、もう1つは非常用として駆動軸により駆動されます。

### ■ 常用ブレーキ

2回路式サーボブレーキが全軸に装備されています。また、エディカレント式電磁ブレーキ (オプション) を装備しています。

### ■ パーキング用ブレーキ

スプリング作動のブレーキが第2～6軸に作動します。

## 走行速度

ギア	1	2	3	4	5	6	7	8	9	10	11	12	R1	R2	傾斜
速度 (km/h)	245-62	7.9	10.3	13.1	16.7	21.4	28.2	36.2	46.8	60	76.1	80	264-67	8.6	50.9%

## 走行軌跡図

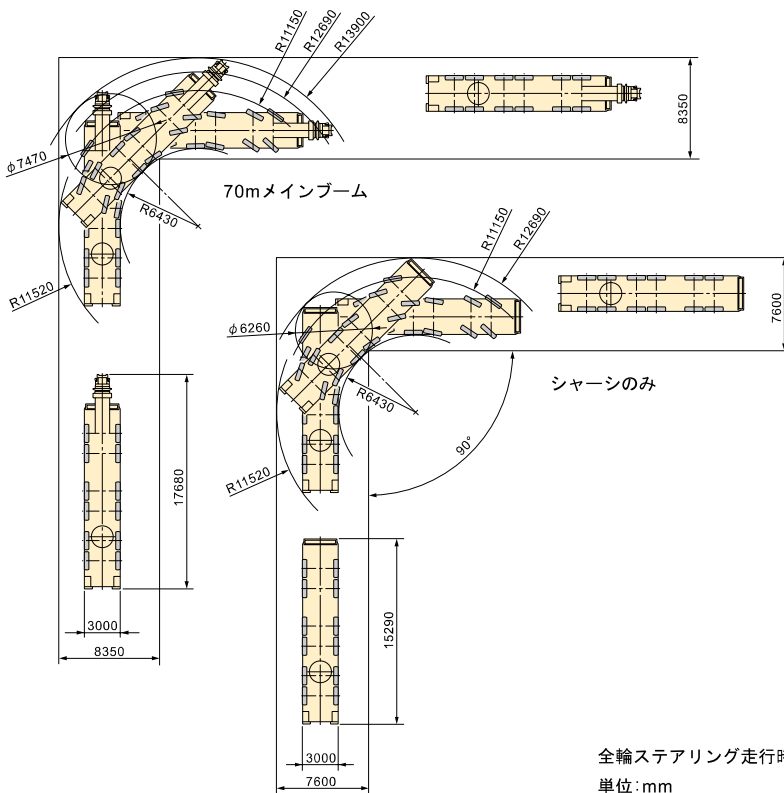

## 駆動部

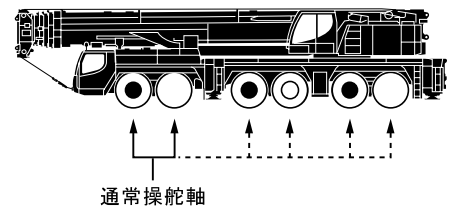

● 駆動軸：常時駆動します。

○：追加駆動軸

第3～6軸は第1～2軸と独立して操舵可能。(リアステアリング操作)

30km/h以下：1、2軸及び3～6軸が電氣的に操舵。

30km/h以上：3、4軸が直進に固定。  
60km/h以上：さらに5、6軸が直進に固定。

ただし、状況により1～3軸が同方向、4～6軸が反対方向に操舵も可能。

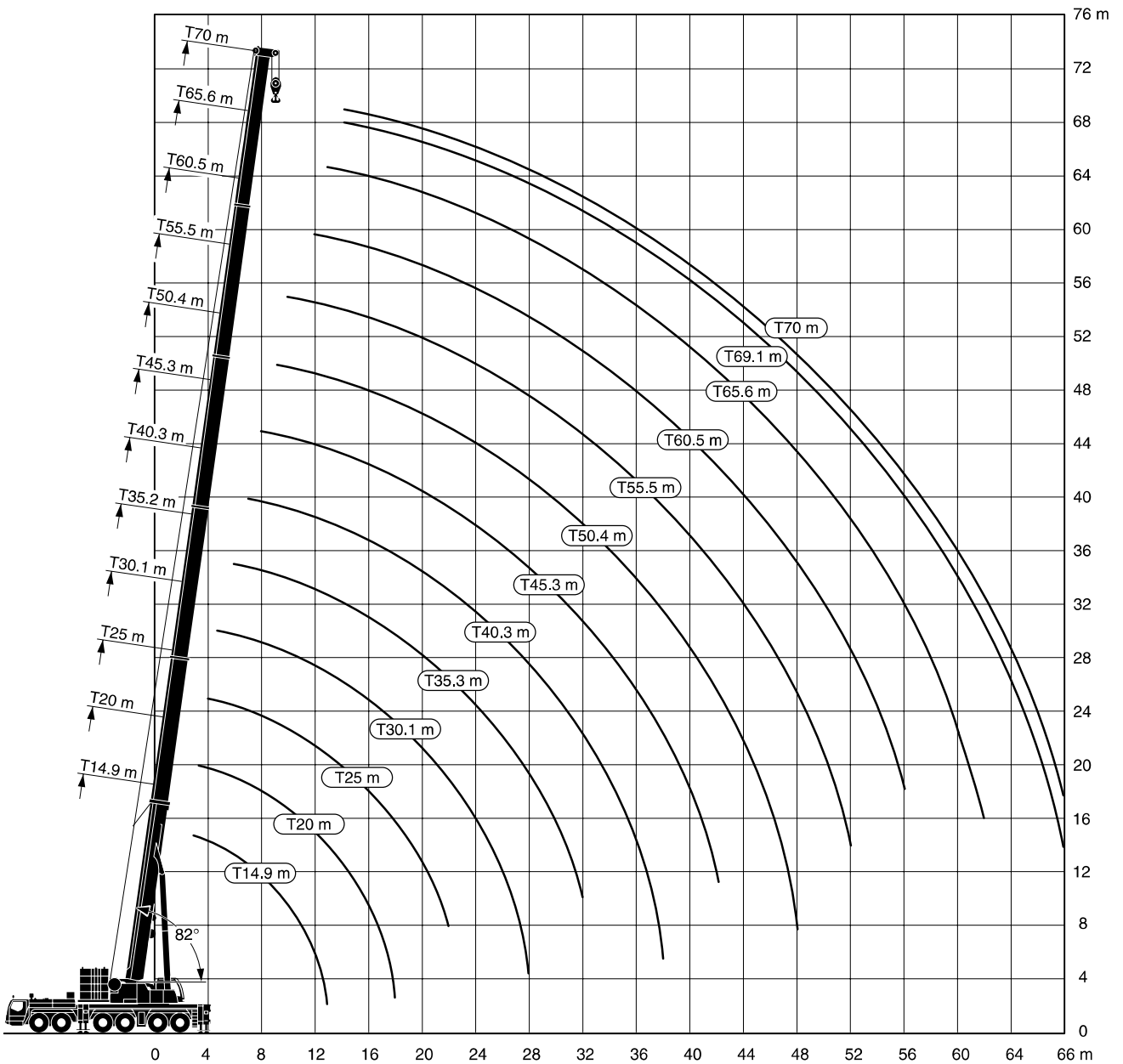

### 注意

- 1 定格総荷重はフックブロック、玉掛ワイヤー等の自重を含みます。  
また、下記の条件が考慮されていないのでクレーンの操作には充分気をつけてください。
  - ① 地盤の強度、地震による影響
  - ② 作業速度に応じた動荷重および台風または強風による影響等
- 2 本機は水平に設置して、クレーン作業を行ってください。
- 3 作業半径は、クレーンの旋回中心から荷重の重心までの水平距離です。
- 4 メインブームの定格総荷重は補助ジブを取り除いた状態での値です。
- 5 メインブーム70m仕様で200トンを超える定格総荷重の場合は、特殊吊装置が必要です。

# メインブーム定格総荷重表 T

# LTM 1400NX



14.9m-70m



8.9m×8.53m



360°



140t

メインブーム 作業半径(m) 長さ	* 14.9m	20m	25m	30.1m	35.2m	40.3m	45.3m	50.4m	55.5m	60.5m	65.6m	69.1m	70m
2.5	400.0												
3	350.0												
3.5	210.1												
4	198.0												
4.5	182.0												
5	170.0												
6	152.6	141.5	141.5										
7	132.0	126.3	127.1	121.1	110.8	80.1							
8	115.2	113.8	114.6	111.3	105.7	90.3	66.1						
9	102.0	103.4	104.3	103.1	97.5	88.9	70.8	54.5	43.2				
10	91.3	94.7	95.4	94.7	90.8	86.9	70.8	52.2	42.4	33.9			
11	82.4	87.1	87.9	87.1	85.1	82.0	70.1	49.7	41.1	33.5			
12	75.0	79.7	81.3	80.5	79.8	77.2	68.1	47.0	39.4	32.9	27.3		
13	51.8	51.8	75.7	74.8	74.4	72.9	65.6	44.6	37.7	31.8	26.9	21.9	
14			70.6	69.7	69.3	68.9	62.6	42.2	36.0	30.7	26.3	21.7	18.3
16			61.6	61.2	60.7	61.5	56.6	38.0	32.9	28.3	24.7	21.1	17.7
18			36.7	53.8	53.7	54.1	51.6	34.0	30.1	26.1	23.0	20.1	16.8
20				47.6	48.4	47.8	47.2	31.5	27.4	24.2	21.4	19.1	15.9
22				38.4	43.3	42.7	43.4	29.2	25.0	22.3	20.0	18.0	15.0
24					39.1	38.4	39.3	27.5	22.9	20.6	18.6	16.9	14.1
26					33.5	34.7	35.6	25.8	21.0	19.1	17.3	15.9	13.3
28					21.5	31.6	32.5	24.3	19.4	17.6	16.1	14.9	12.6
30						29.1	29.8	23.1	17.9	16.3	15.0	13.9	11.8
32						23.0	27.4	21.9	17.0	15.1	14.0	13.1	11.1
34							25.1	20.9	16.1	14.0	13.0	12.2	10.5
36							20.7	20.0	15.3	13.1	12.1	11.5	9.8
38							14.0	19.2	14.6	12.3	11.3	10.8	9.2
40								18.5	13.8	11.6	10.7	10.1	8.7
42								14.7	13.2	11.1	10.1	9.5	8.2
44									12.7	10.5	9.5	8.9	7.7
46									12.2	10.1	9.0	8.3	7.3
48									8.9	9.6	8.5	7.8	6.9
50										9.3	8.1	7.3	6.5
52										8.9	7.7	6.9	6.1
54											7.3	6.4	5.8
56											7.0	6.0	5.5
58											5.6	5.7	5.2
60												5.3	4.9
62												4.9	4.7
64													4.4
66													4.1

\*後方吊、カウンターウエイト100t

50301



14.9m-70m

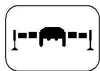

8.9m×8.53m



360°



100t

メインブーム 作業半径(m) 長さ	14.9m	20m	25m	30.1m	35.2m	40.3m	45.3m	50.4m	55.5m	60.5m	65.6m	69.1m	70m
3	155.7												
3.5	155.7	155.7											
4	155.7	155.7	155.2										
4.5	155.7	155.7	154.8	114.6									
5	155.1	154.7	146.8	114.6									
6	137.2	137.9	133.3	114.6	93.0								
7	122.4	123.2	121.1	111.2	91.6	70.8							
8	110.2	111.1	110.3	105.7	90.3	70.8	55.7						
9	100.2	101.0	100.3	97.5	88.9	70.8	54.5	43.2					
10	91.3	92.2	91.2	90.2	86.9	70.8	52.2	42.4	33.9				
11	82.4	83.3	82.5	82.2	82.0	70.1	49.7	41.1	33.5				
12	75.0	75.9	75.1	75.8	75.6	68.1	47.0	39.4	32.9	27.3			
13	51.8	69.7	68.8	69.8	69.2	65.6	44.6	37.7	31.8	26.9	21.9		
14		64.2	64.3	64.3	63.7	62.6	42.2	36.0	30.7	26.3	21.7	18.3	17.7
16		55.2	55.5	55.3	54.7	55.7	38.0	32.9	28.3	24.7	21.1	17.7	17.2
18		36.7	48.5	48.3	47.7	48.7	34.0	30.1	26.1	23.0	20.1	16.8	16.5
20			42.9	42.7	42.9	43.0	31.5	27.4	24.2	21.4	19.1	15.9	15.6
22			37.9	38.0	39.0	38.3	29.2	25.0	22.3	20.0	18.0	15.0	14.8
24				33.8	34.9	34.1	27.5	22.9	20.6	18.6	16.9	14.1	14.0
26				31.3	31.2	30.4	25.8	21.0	19.1	17.3	15.9	13.3	13.2
28				21.5	28.1	27.3	24.3	19.4	17.6	16.1	14.9	12.6	12.5
30					25.5	24.7	23.1	17.9	16.3	15.0	13.9	11.8	11.7
32					22.5	22.4	21.9	17.0	15.1	14.0	13.1	11.1	11.0
34						20.4	20.8	16.1	14.0	13.0	12.2	10.5	10.4
36							18.7	14.4	13.1	12.1	11.5	9.8	9.7
38							14.0	17.8	14.6	12.3	11.3	10.8	9.2
40								16.4	13.8	11.6	10.7	10.1	8.7
42								14.6	13.2	11.1	10.1	9.5	8.2
44									12.7	10.5	9.5	8.9	7.7
46									12.2	10.1	9.0	8.3	7.3
48									8.9	9.6	8.5	7.8	6.9
50										9.3	8.1	7.3	6.5
52										8.9	7.7	6.9	6.1
54											7.3	6.4	5.8
56											7.0	6.0	5.5
58											5.6	5.7	5.2
60												5.3	4.9
62												4.9	4.7
64													4.4
66													4.1

50305

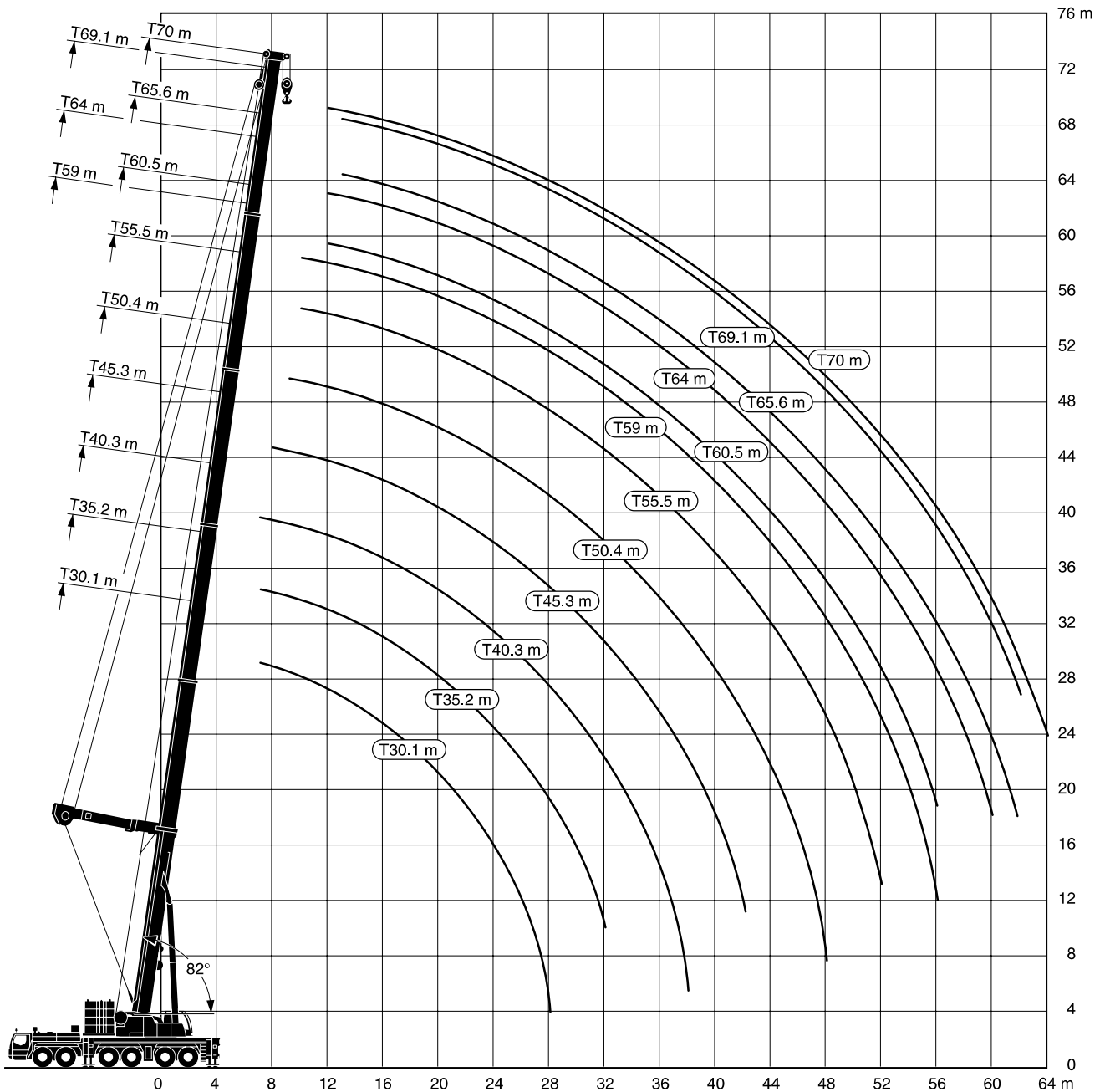

**注意**

- 1 定格総荷重はフックブロック、玉掛ワイヤー等の自重を含みます。  
また、下記の条件が考慮されていませんのでクレーンの操作には充分気をつけてください。
  - ① 地盤の強度、地震による影響
  - ② 作業速度に応じた動荷重および台風または強風による影響等
- 2 本機は水平に設置して、クレーン作業を行ってください。
- 3 作業半径は、クレーンの旋回中心から荷重の重心までの水平距離です。
- 4 メインブームの定格総荷重は補助ジブを取り除いた状態での値です。
- 5 メインブーム70m仕様で200トンを超える定格総荷重の場合は、特殊吊装置が必要です。

# メインブーム(ガイ仕様) 定格総荷重表 TY

# LTM 1400NX



30.1m-70m



8.9m×8.53m



360°



140t



Y-ガイ

メインブーム長さ 作業半径(m)	30.1m	35.2m	40.3m	45.3m	50.4m	55.5m	59m	60.5m	64m	65.6m	69.1m	70m
8	106.8	98.5										
9	99.6	94.9	84.6									
10	92.4	89.2	83.2	75.5								
11	87.1	83.5	78.6	73.9								
12	80.7	78.6	74.9	71.0	65.4							
13	74.7	74.0	70.7	67.6	63.0	56.4	51.2	48.1		42.6		36.4
14	69.4	69.7	67.4	64.3	60.3	55.8	50.8	47.8	43.6	42.2	37.1	36.1
16	60.5	61.1	61.0	58.7	55.5	52.3	48.3	46.8	42.5	41.0	35.6	35.4
18	53.2	54.0	54.6	53.4	50.9	47.9	45.6	44.9	40.7	38.8	33.8	34.3
20	47.3	48.0	48.7	48.4	47.0	44.2	42.7	41.8	38.6	36.8	32.0	32.8
22	42.0	42.9	43.7	43.8	43.1	41.1	39.7	38.8	36.7	34.9	30.5	31.3
24	37.4	38.4	39.0	39.2	39.3	38.0	36.9	36.2	34.8	33.3	29.1	29.8
26	30.6	34.4	35.2	35.3	35.5	35.1	34.3	33.6	32.7	31.4	27.9	28.6
28	16.5	31.0	31.8	32.0	32.1	32.0	31.8	31.3	30.5	29.2	26.7	27.3
30		26.7	28.9	29.1	29.2	29.1	29.2	29.0	28.5	27.2	25.6	26.1
32		19.4	26.4	26.5	26.7	26.5	26.7	26.5	26.5	25.4	24.5	24.7
34			23.3	24.3	24.5	24.3	24.4	24.2	24.4	23.6	23.3	23.2
36			18.5	22.3	22.5	22.3	22.4	22.2	22.4	21.7	21.7	21.6
38			10.0	20.0	20.7	20.5	20.6	20.4	20.6	19.9	20.0	20.0
40				16.5	19.0	18.9	19.1	18.8	19.0	18.3	18.5	18.5
42				11.6	17.3	17.4	17.6	17.3	17.5	16.7	17.0	17.0
44					14.6	15.9	16.1	15.9	16.1	15.3	15.6	15.7
46					11.2	14.6	14.9	14.6	14.8	14.0	14.3	14.3
48					5.4	12.4	13.7	13.4	13.6	12.9	13.1	13.2
50						9.8	12.1	12.3	12.5	11.7	12.0	12.0
52						6.3	10.1	10.6	11.5	10.7	10.9	11.0
54							7.6	8.5	10.3	9.8	10.0	10.1
56							3.9	6.0	8.6	8.4	9.2	9.2
58									6.7	6.8	8.2	8.3
60									4.1	4.8	6.8	7.1
62										2.3	5.3	5.7
64											3.4	3.9
66												1.8

60101



30.1m-70m



8.9m×8.53m



360°



100t



Y-ガイ

メインブーム長さ 作業半径(m)	30.1m	35.2m	40.3m	45.3m	50.4m	55.5m	59m	60.5m	64m	65.6m	69.1m	70m
4.5	116.1											
5	118.4											
6	119.0	104.9										
7	116.9	106.9	90.3									
8	108.4	101.6	90.2	75.7								
9	99.6	94.9	88.5	76.1	65.8							
10	91.6	89.2	84.8	76.1	66.0							
11	84.7	83.5	79.6	74.7	66.0	56.5	51.4	48.2				
12	77.6	77.8	74.9	71.0	65.4	56.5	51.4	48.2	44.0	42.8		36.2
13	70.8	71.5	70.7	67.6	63.0	56.4	51.2	48.1	43.9	42.6	37.8	36.4
14	65.0	65.6	66.0	64.3	60.3	55.8	50.8	47.8	43.6	42.2	37.1	36.1
16	55.3	56.2	56.8	57.0	55.5	52.3	48.3	46.8	42.5	41.0	35.6	35.4
18	47.8	48.6	49.4	49.5	49.5	47.7	45.6	44.9	40.7	38.8	33.8	34.3
20	41.8	42.6	43.4	43.5	43.6	42.5	41.8	41.1	38.6	36.8	32.0	32.8
22	36.7	37.6	38.4	38.5	38.7	37.8	37.3	36.7	36.0	34.8	30.5	31.3
24	32.6	33.5	34.2	34.4	34.5	33.9	33.4	32.9	32.5	31.3	29.1	29.7
26	28.7	29.8	30.7	30.8	31.0	30.5	30.1	29.6	29.3	28.2	27.5	27.9
28	16.5	26.5	27.4	27.6	27.8	27.5	27.2	26.7	26.5	25.4	25.2	25.1
30		23.5	24.5	24.8	24.9	24.7	24.6	24.2	24.0	22.9	22.8	22.7
32		19.4	22.0	22.2	22.4	22.2	22.3	21.9	21.7	20.7	20.6	20.6
34			19.7	20.0	20.2	20.0	20.2	19.9	19.8	18.8	18.7	18.7
36			17.7	18.0	18.2	18.0	18.2	17.9	18.0	17.0	17.0	17.0
38			10.0	16.2	16.5	16.3	16.5	16.2	16.4	15.4	15.5	15.5
40				14.6	14.9	14.7	14.9	14.6	14.8	14.0	14.1	14.1
42				11.6	13.5	13.3	13.5	13.2	13.4	12.6	12.8	12.8
44					12.2	12.0	12.2	12.0	12.2	11.4	11.6	11.6
46					10.9	10.8	11.0	10.8	11.0	10.2	10.5	10.5
48					5.4	9.8	10.0	9.7	9.9	9.2	9.4	9.5
50						8.8	9.0	8.7	8.9	8.2	8.5	8.5
52						6.3	8.1	7.8	8.0	7.3	7.5	7.6
54							7.2	6.9	7.2	6.5	6.7	6.7
56							3.9	5.7	6.4	5.7	5.9	6.0
58									5.7	5.0	5.2	5.2
60									4.1	4.3	4.6	4.6
62										2.3	3.9	3.9
64											3.1	3.3
66												1.8

60105

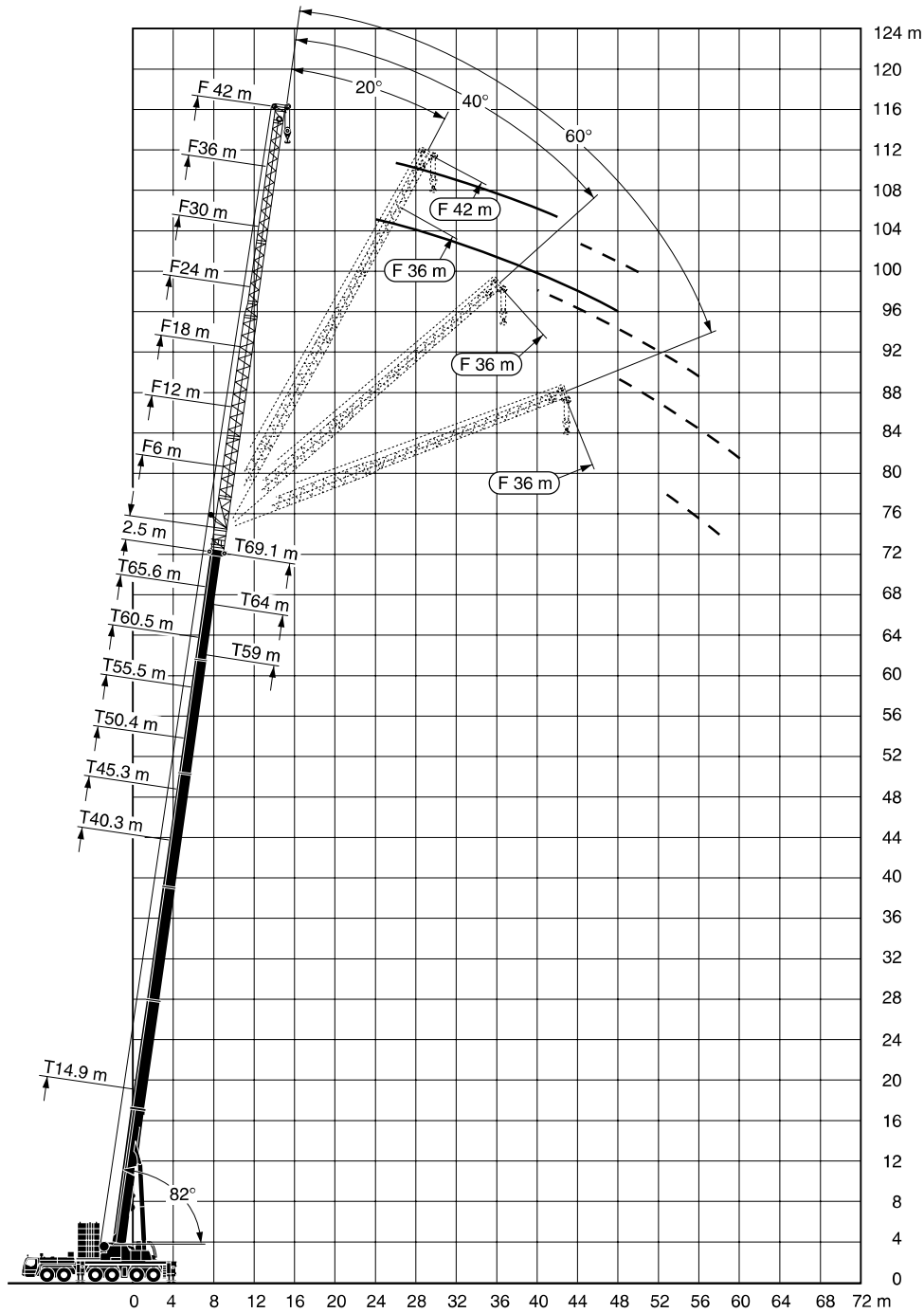

**注意**

- 1 定格総荷重はフックブロック、玉掛ワイヤー等の自重を含みます。  
また、下記の条件が考慮されていないのでクレーンの操作には充分気をつけてください。
  - ① 地盤の強度、地震による影響
  - ② 作業速度に応じた動荷重および台風または強風による影響等
- 2 本機は水平に設置して、クレーン作業を行ってください。
- 3 作業半径は、クレーンの旋回中心から荷重の重心までの水平距離です。
- 4 メインブームの定格総荷重は補助ジブを取り除いた状態での値です。
- 5 メインブーム70m仕様で200トンを超える定格総荷重の場合は、特殊吊装置が必要です。

# 固定式ジブ定格総荷重表 TF

# LTM 1400NX



14.9m—65.6m



0°/20°/40°/60°  
6m

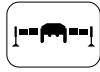

8.9m×8.53m



360°



100t

メインブーム長さ ジブ長さ 作業半径(m)	14.9m+2.5m 6m				40.3m+2.5m 6m				45.3m+2.5m 6m				50.4m+2.5m 6m			
	0°	20°	40°	60°	0°	20°	40°	60°	0°	20°	40°	60°	0°	20°	40°	60°
3.5	45.0															
4.0	44.4															
4.5	43.0															
5	41.1															
6	37.4	33.1														
7	34.2	30.6	27.7													
8	31.3	28.4	26.0	24.3	45.0											
9	28.9	26.5	24.5	23.9	44.4											
10	26.8	24.9	23.2	22.8	43.0	34.4			36.2							
11	25.1	23.4	22.1	21.9	41.1	33.1			36.2				29.7			
12	23.4	22.2	21.0	21.1	39.3	31.9	27.2		35.9	31.4			29.4			
13	22.0	21.1	20.1	20.7	37.7	30.7	26.4	24.3	34.8	30.4	26.2		28.8			
14	20.7	20.0	19.3	20.2	36.0	29.6	25.7	24.3	33.3	29.5	25.6	24.1	27.7	27.5		
16	18.6	18.2	18.0	14.6	33.1	27.8	24.4	23.3	30.5	27.7	24.4	23.2	25.5	25.4	24.2	22.9
18	17.0	16.7	16.9	5.5	30.5	26.1	23.2	22.4	28.0	26.2	23.4	22.4	23.5	23.5	23.2	22.1
20	15.7	15.7	9.0		28.4	24.6	22.2		25.7	24.8	22.5	21.7	21.8	21.7	21.8	21.5
22					26.4	23.3	21.3		23.5	23.3	21.5		20.1	20.1	20.2	20.4
24					24.8	22.2	20.5		21.5	21.5	20.7		18.6	18.6	18.7	
26					23.3	21.2	19.7		19.8	19.7	19.6		17.2	17.2	17.2	
28					22.0	20.2	19.1		18.2	18.2	18.3		15.9	15.9	16.0	
30					20.8	19.3	18.5		16.7	16.8	16.8		14.6	14.7	14.8	
32					19.7	18.5	18.0		15.4	15.5	15.6		13.4	13.5	13.7	
34					18.8	17.8			14.2	14.3	14.4		12.4	12.5	12.7	
36					17.7	17.1			13.1	13.2			11.4	11.5	11.7	
38					16.3	16.4			12.2	12.2			10.5	10.6	10.8	
40					14.8	15.1			11.4	11.4			9.7	9.8		
42					13.6				10.7	10.7			9.0	9.0		
44					12.4				10.0	10.0			8.3	8.4		
46					9.0				9.4	9.4			7.7	7.9		
48									8.9				7.2	7.3		
50									8.4				6.8	6.8		
52													6.3			
54													5.9			
56													4.8			

メインブーム長さ ジブ長さ 作業半径(m)	55.5m+2.5m 6m				60.5m+2.5m 6m				65.6m+2.5m 6m			
	0°	20°	40°	60°	0°	20°	40°	60°	0°	20°	40°	60°
12	23.6											
13	23.4											
14	23.1				18.7							
16	21.6	21.5			18.2	17.9				14.9		
18	20.0	20.0	20.3	20.6	17.2	17.1	17.1			14.5	14.2	
20	18.6	18.7	18.9	19.3	16.0	16.1	16.2	16.5	13.8	13.7	13.8	
22	17.3	17.4	17.6	17.9	15.0	15.1	15.3	15.5	13.0	13.0	13.1	13.3
24	16.0	16.2	16.3	16.6	13.9	14.1	14.4	14.6	12.3	12.3	12.4	12.7
26	14.9	15.0	15.2		13.0	13.2	13.4	13.7	11.5	11.6	11.8	12.0
28	13.8	14.0	14.1		12.1	12.3	12.5		10.8	11.0	11.1	11.3
30	12.8	13.0	13.1		11.3	11.5	11.7		10.1	10.3	10.5	
32	11.9	12.0	12.1		10.5	10.7	10.9		9.4	9.7	9.8	
34	11.0	11.2	11.3		9.8	10.0	10.2		8.8	9.0	9.2	
36	10.2	10.3	10.4		9.1	9.3	9.4		8.2	8.4	8.6	
38	9.4	9.6	9.7		8.4	8.6	8.7		7.6	7.9	8.0	
40	8.6	8.8	8.9		7.8	8.0	8.1		7.1	7.3	7.5	
42	7.9	8.1	8.2		7.2	7.4	7.5		6.6	6.8	7.0	
44	7.3	7.5			6.6	6.8	6.9		6.1	6.4	6.4	
46	6.7	6.9			6.1	6.3			5.7	5.9	6.0	
48	6.2	6.4			5.6	5.8			5.2	5.4	5.5	
50	5.8	5.9			5.2	5.3			4.8	5.0		
52	5.4	5.5			4.8	4.9			4.4	4.6		
54	5.0	5.1			4.5	4.6			4.0	4.2		
56	4.6				4.1	4.2			3.6	3.8		
58	4.3				3.8	3.9			3.3	3.4		
60	4.0				3.5				3.0	3.1		
62					3.3				2.7	2.8		
64					3.1				2.4			
66					2.8				2.1			
68									1.9			
70									1.6			

51105/25/45/65

# 固定式ジブ定格総荷重表 TF

# LTM 1400NX



14.9m-65.6m



0°/20°/40°/60°  
12m

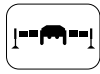

8.9m x 8.53m



360°



100t

メインブーム長さ ジブ長さ 作業半径(m)	14.9m+2.5m 12m				40.3m+2.5m 12m				45.3m+2.5m 12m				50.4m+2.5m 12m			
	0°	20°	40°	60°	0°	20°	40°	60°	0°	20°	40°	60°	0°	20°	40°	60°
4.5	32.4															
5	31.5															
6	29.0															
7	26.9															
8	25.0															
9	23.3	20.3														
10	21.7	19.0			31.2											
11	20.2	17.9			29.8				28.5							
12	18.9	16.9	15.3		28.6				27.5				23.8			
13	17.7	16.0	14.6		27.5				26.5				23.7			
14	16.7	15.2	14.0	12.2	26.4	20.2			25.6				23.5			
16	15.0	13.8	12.9	12.2	24.4	18.9			24.0	18.8			22.2			
18	13.5	12.6	11.9	12.1	22.7	17.8	14.9	12.2	22.5	17.8	14.9		20.7	17.4		
20	12.3	11.7	11.2	11.8	20.9	16.8	14.2	12.2	21.1	16.8	14.3	12.2	19.3	16.6	14.1	
22	11.3	10.9	10.6	11.3	19.5	15.8	13.6	12.2	19.8	16.0	13.7	12.2	18.0	15.8	13.6	12.2
24	10.5	10.3	10.2	4.4	18.2	15.0	13.1	12.2	18.5	15.2	13.2	12.2	16.8	15.1	13.1	12.2
26	9.9	9.8	7.5		17.1	14.3	12.6		17.5	14.5	12.7	12.2	15.6	14.5	12.7	12.2
28					16.1	13.6	12.2		16.4	13.9	12.3		14.6	13.9	12.3	12.0
30					15.1	13.0	11.8		15.4	13.3	12.0		13.6	13.2	12.0	
32					14.3	12.5	11.5		14.4	12.8	11.6		12.6	12.6	11.6	
34					13.6	12.0	11.1		13.4	12.3	11.3		11.7	11.8	11.3	
36					13.0	11.6	10.9		12.4	11.9	11.0		10.8	11.0	10.9	
38					12.3	11.2	10.6		11.5	11.4	10.8		10.1	10.2	10.4	
40					11.8	10.8			10.7	10.9	10.6		9.3	9.5	9.7	
42					11.3	10.5			9.9	10.2			8.6	8.8	9.0	
44					10.9	10.2			9.2	9.5			8.0	8.2	8.4	
46					10.5	10.0			8.5	8.8			7.4	7.6		
48					10.2				8.0	8.2			6.8	7.0		
50					9.9				7.5	7.7			6.3	6.5		
52					6.9				7.1				5.8	6.0		
54									6.7				5.4	5.5		
56									6.3				5.0	5.1		
58													4.7			
60													4.4			
62													3.4			

メインブーム長さ ジブ長さ 作業半径(m)	55.5m+2.5m 12m				60.5m+2.5m 12m				65.6m+2.5m 12m			
	0°	20°	40°	60°	0°	20°	40°	60°	0°	20°	40°	60°
14	18.8											
16	18.4				14.8							
18	17.5				14.5					11.7		
20	16.4	15.9			13.9					11.4		
22	15.4	15.2	13.2		13.1	13.1				11.0	10.4	
24	14.4	14.5	12.8	12.2	12.4	12.4	11.9			10.5	10.0	
26	13.4	13.7	12.4	12.0	11.6	11.7	11.3	11.4	11.4	10.0	9.5	9.2
28	12.5	12.8	12.1	11.8	10.9	11.1	10.8	10.9	10.9	9.5	9.1	8.8
30	11.7	12.0	11.8	11.6	10.2	10.5	10.3	10.4	10.4	9.0	8.7	8.5
32	10.9	11.2	11.3		9.5	9.8	9.8	9.9	9.9	8.4	8.3	8.1
34	10.2	10.4	10.7		8.9	9.2	9.3			7.9	8.0	7.8
36	9.5	9.7	9.9		8.3	8.6	8.7			7.4	7.6	7.5
38	8.9	9.0	9.2		7.8	8.1	8.2			6.9	7.1	7.2
40	8.2	8.4	8.6		7.3	7.5	7.7			6.5	6.7	6.8
42	7.6	7.8	8.0		6.8	7.0	7.2			6.1	6.3	6.5
44	7.0	7.2	7.4		6.3	6.5	6.7			5.6	5.9	6.1
46	6.4	6.7	6.8		5.8	6.0	6.2			5.2	5.5	5.7
48	5.9	6.2	6.3		5.3	5.5	5.7			4.8	5.1	5.3
50	5.5	5.7			4.9	5.1	5.3			4.5	4.8	4.9
52	5.0	5.2			4.5	4.7				4.1	4.4	4.5
54	4.6	4.7			4.1	4.3				3.8	4.0	4.1
56	4.3	4.4			3.8	3.9				3.5	3.7	
58	3.9	4.0			3.5	3.6				3.1	3.4	
60	3.7	3.7			3.2	3.4				2.8	3.1	
62	3.4				3.0	3.1				2.5	2.8	
64	3.2				2.8	2.9				2.3	2.5	
66	3.0				2.6					2.0	2.2	
68					2.4					1.7	2.0	
70					2.2					1.5		
72					1.7					1.3		

51205/25/45/65

# 固定式ジブ定格総荷重表 TF

# LTM 1400NX



14.9m—65.6m



0°/20°/40°/60°  
18m

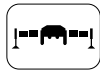

8.9m×8.53m



360°



100t

メインブーム長さ ジブ長さ 作業半径(m)	14.9m+2.5m 18m				40.3m+2.5m 18m				45.3m+2.5m 18m				50.4m+2.5m 18m			
	0°	20°	40°	60°	0°	20°	40°	60°	0°	20°	40°	60°	0°	20°	40°	60°
6	23.5															
7	22.0															
8	20.5															
9	19.3															
10	18.1															
11	17.1				23.3											
12	16.1	13.9			22.3				21.3							
13	15.1	13.2			21.5				20.6							
14	14.3	12.5			20.6				19.9							
16	12.7	11.3			19.2				18.6				18.5			
18	11.5	10.3	9.8		17.8	13.4			17.5	13.4			17.6			
20	10.4	9.4	9.0	7.1	16.7	12.6			16.5	12.6			15.8	12.2		
22	9.5	8.7	8.4	7.0	15.5	11.9	10.2		15.5	12.0			15.0	12.1		
24	8.7	8.1	7.9	6.9	14.5	11.3	9.8		14.6	11.4	9.8		14.3	11.5	9.6	
26	8.0	7.5	7.5	6.8	13.5	10.7	9.4	7.1	13.8	10.8	9.4	7.1	13.6	11.0	9.3	
28	7.5	7.1	7.1	6.6	12.7	10.2	9.0	7.0	13.0	10.3	9.1	7.0	12.9	10.5	9.0	7.0
30	7.0	6.7	6.9		12.0	9.7	8.7	7.0	12.2	9.9	8.8	7.0	12.2	10.1	8.7	7.0
32	6.6	6.5			11.3	9.3	8.4		11.6	9.5	8.5	6.9	11.5	9.7	8.4	6.9
34					10.6	8.9	8.1		11.0	9.1	8.2		10.8	9.3	8.2	6.9
36					10.1	8.5	7.9		10.4	8.7	8.0		10.2	9.0	8.0	
38					9.6	8.2	7.7		10.0	8.4	7.8		9.5	8.7	7.8	
40					9.1	7.9	7.5		9.5	8.1	7.6		8.8	8.4	7.6	
42					8.7	7.6	7.3		9.0	7.8	7.4		8.2	8.1	7.4	
44					8.3	7.3	7.1		8.6	7.6	7.2		7.6	7.7	7.3	
46					7.9	7.1			8.2	7.4	7.1		7.0	7.3	7.2	
48					7.6	6.9			7.7	7.2			6.5	6.9	7.0	
50					7.3	6.8			7.2	7.0			6.0	6.4	6.6	
52					7.0	6.6			6.7	6.7			5.6	5.9		
54					6.8				6.2	6.4			5.1	5.5		
56					6.6				5.8	6.0			4.7	5.1		
58					5.3				5.5				4.4	4.7		
60									5.2				4.1	4.3		
62									4.7				3.8	3.9		
64													3.5			
66													3.3			
68													2.4			

メインブーム長さ ジブ長さ 作業半径(m)	55.5m+2.5m 18m				60.5m+2.5m 18m				65.6m+2.5m 18m			
	0°	20°	40°	60°	0°	20°	40°	60°	0°	20°	40°	60°
16	15.4				11.6							
18	15.1				11.6				9.2			
20	14.4				11.3				9.1			
22	13.6	11.5			11.0				8.9			
24	12.8	11.1			10.6	10.3			8.6			
26	12.0	10.6	9.0		10.1	9.9			8.3	7.9		
28	11.3	10.2	8.8	7.0	9.6	9.5			8.0	7.6		
30	10.6	9.8	8.5	6.9	9.1	9.0	8.2	6.9	7.7	7.2	6.8	
32	9.9	9.5	8.3	6.9	8.6	8.6	8.0	6.9	7.3	6.9	6.6	
34	9.3	9.1	8.1	6.9	8.1	8.2	7.8	6.9	7.0	6.6	6.4	6.3
36	8.7	8.8	7.9	6.9	7.6	7.8	7.6	6.9	6.6	6.4	6.1	6.2
38	8.1	8.4	7.7		7.1	7.4	7.3	6.9	6.3	6.1	5.9	5.9
40	7.6	7.9	7.5		6.7	7.0	7.0		5.9	5.9	5.7	5.7
42	7.1	7.4	7.4		6.2	6.6	6.7		5.5	5.6	5.5	
44	6.6	6.9	7.1		5.8	6.2	6.3		5.2	5.3	5.3	
46	6.1	6.4	6.7		5.4	5.8	6.0		4.8	5.1	5.1	
48	5.7	6.0	6.2		5.0	5.3	5.6		4.5	4.8	4.8	
50	5.2	5.6	5.8		4.7	5.0	5.2		4.2	4.5	4.6	
52	4.8	5.2	5.3		4.3	4.6	4.8		3.9	4.2	4.4	
54	4.4	4.8	4.9		4.0	4.2	4.4		3.6	3.9	4.0	
56	4.0	4.4			3.7	3.9	4.1		3.3	3.6	3.7	
58	3.7	4.0			3.3	3.6			3.0	3.3	3.4	
60	3.4	3.6			3.0	3.3			2.7	3.0	3.2	
62	3.2	3.3			2.8	3.0			2.5	2.7		
64	3.0	3.1			2.6	2.7			2.2	2.4		
66	2.7	2.8			2.4	2.5			1.9	2.2		
68	2.6				2.2	2.3			1.7	1.9		
70	2.4				2.0	2.1			1.5	1.7		
72	2.2				1.8				1.2	1.4		
74					1.7					1.2		
76					1.5							

51305/25/45/65

# 固定式ジブ定格総荷重表 TF

# LTM 1400NX



14.9m-65.6m



0°/20°/40°/60°  
24m

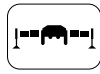

8.9m x 8.53m



360°



100t

メインブーム長さ ジブ長さ 作業半径(m)	14.9m+2.5m 24m				40.3m+2.5m 24m				45.3m+2.5m 24m				50.4m+2.5m 24m			
	角度				角度				角度				角度			
	0°	20°	40°	60°	0°	20°	40°	60°	0°	20°	40°	60°	0°	20°	40°	60°
7	17.9															
8	17.0															
9	16.0															
10	15.1															
11	14.3															
12	13.5				17.7											
13	12.8				17.1				16.3							
14	12.2				16.5				15.8							
16	11.0	10.0			15.3				14.8				13.9			
18	9.8	9.0			14.3				13.9				13.2			
20	8.9	8.2			13.4	10.4			13.1				12.5			
22	8.1	7.5	6.8		12.6	9.8			12.4	9.7			11.9			
24	7.4	6.9	6.4		11.8	9.2			11.7	9.2			11.3	9.0		
26	6.8	6.4	6.0	4.3	11.0	8.7	7.0		11.1	8.7			10.7	8.6		
28	6.2	6.0	5.6	4.2	10.3	8.3	6.7		10.4	8.3	6.7		10.2	8.2		
30	5.8	5.6	5.3	4.1	9.7	7.8	6.5	4.3	9.9	7.9	6.5		9.7	7.8	6.5	
32	5.3	5.2	5.0	4.1	9.1	7.5	6.3	4.2	9.3	7.5	6.3	4.3	9.3	7.5	6.3	4.2
34	5.0	4.9	4.8	4.0	8.6	7.1	6.1	4.2	8.8	7.2	6.1	4.2	8.8	7.2	6.1	4.2
36	4.7	4.7	4.6		8.1	6.8	5.9	4.2	8.3	6.9	5.9	4.2	8.4	6.9	5.9	4.2
38	4.5	4.5			7.6	6.5	5.7		7.9	6.6	5.7	4.1	8.0	6.6	5.7	4.1
40					7.2	6.2	5.5		7.5	6.3	5.5		7.6	6.4	5.5	4.1
42					6.8	5.9	5.3		7.1	6.1	5.4		7.3	6.1	5.4	
44					6.5	5.7	5.2		6.8	5.9	5.2		6.9	5.9	5.3	
46					6.2	5.5	5.0		6.5	5.7	5.1		6.5	5.7	5.1	
48					5.9	5.3	4.9		6.2	5.5	5.0		6.1	5.5	5.0	
50					5.6	5.1	4.8		5.9	5.3	4.9		5.6	5.4	4.9	
52					5.4	4.9			5.7	5.1	4.8		5.3	5.2	4.8	
54					5.2	4.8			5.4	5.0			4.8	5.0	4.8	
56					4.9	4.7			5.2	4.8			4.5	4.8	4.7	
58					4.8	4.6			5.0	4.7			4.1	4.5		
60					4.6				4.7	4.6			3.8	4.2		
62					4.5				4.3	4.5			3.4	3.8		
64					3.8				4.1				3.2	3.5		
66									3.8				3.0	3.2		
68									3.4				2.8	2.9		
70													2.6			
72													2.4			
74													1.6			

メインブーム長さ ジブ長さ 作業半径(m)	55.5m+2.5m 24m				60.5m+2.5m 24m				65.6m+2.5m 24m			
	角度				角度				角度			
	0°	20°	40°	60°	0°	20°	40°	60°	0°	20°	40°	60°
18	11.9				9.6							
20	11.6				9.5				7.5			
22	11.2				9.3				7.4			
24	10.8				9.0				7.2			
26	10.3	8.3			8.7				6.9			
28	9.9	7.9			8.3	7.4			6.7			
30	9.4	7.6			7.9	7.2			6.4	5.8		
32	8.9	7.3	6.2		7.5	6.9			6.2	5.6		
34	8.4	7.0	6.0	4.2	7.1	6.7	5.8		5.9	5.4		
36	7.9	6.8	5.8	4.1	6.7	6.5	5.6	4.1	5.6	5.2	4.6	
38	7.4	6.5	5.6	4.1	6.3	6.2	5.5	4.1	5.4	5.0	4.5	
40	6.9	6.3	5.5	4.1	6.0	6.0	5.3	4.1	5.1	4.8	4.4	4.1
42	6.5	6.1	5.3	4.1	5.6	5.8	5.2	4.1	4.8	4.6	4.2	4.1
44	6.1	5.9	5.2		5.2	5.5	5.1	4.1	4.5	4.4	4.1	4.1
46	5.7	5.7	5.1		4.9	5.2	5.0		4.2	4.2	4.0	4.0
48	5.3	5.4	5.0		4.5	4.9	4.9		4.0	4.0	3.9	
50	4.9	5.2	4.9		4.2	4.6	4.7		3.7	3.8	3.7	
52	4.5	4.9	4.8		3.9	4.3	4.5		3.4	3.7	3.6	
54	4.2	4.5	4.6		3.6	4.0	4.2		3.1	3.5	3.5	
56	3.9	4.2	4.4		3.3	3.7	3.9		2.9	3.2	3.3	
58	3.5	3.8	4.0		3.0	3.4	3.6		2.6	3.0	3.2	
60	3.2	3.5			2.7	3.1	3.3		2.4	2.7	3.0	
62	2.9	3.2			2.5	2.8	3.0		2.1	2.5	2.8	
64	2.7	2.9			2.3	2.5			1.9	2.2	2.5	
66	2.5	2.7			2.0	2.3			1.7	2.0	2.2	
68	2.3	2.4			1.8	2.1			1.4	1.8		
70	2.1	2.2			1.7	1.8			1.2	1.5		
72	1.9	2.0			1.5	1.6				1.2		
74	1.7				1.3	1.4						
76	1.5					1.3						

51405/25/45/65

# 固定式ジブ定格総荷重表 TF

# LTM 1400NX



14.9m—65.6m



0°/20°/40°/60°  
30m

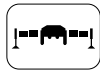

8.9m×8.53m



360°



100t

メインブーム長さ ジブ長さ 作業半径(m)	14.9m+2.5m 30m				40.3m+2.5m 30m				45.3m+2.5m 30m				50.4m+2.5m 30m			
	0°	20°	40°	60°	0°	20°	40°	60°	0°	20°	40°	60°	0°	20°	40°	60°
8	12.2															
9	12.2															
10	12.2															
11	12.2															
12	11.8															
13	11.2				12.2											
14	10.7				12.2				12.2							
16	9.7				12.2				12.2				11.3			
18	8.9	7.6			12.0				11.6				10.9			
20	8.0	7.1			11.3				11.0				10.3			
22	7.3	6.5			10.6				10.4				9.8			
24	6.6	6.0			10.0	7.4			9.8				9.4			
26	6.0	5.5	4.6		9.4	7.1			9.3	7.0			8.9			
28	5.5	5.1	4.4		8.9	6.7			8.8	6.7			8.5	6.6		
30	5.1	4.7	4.1		8.3	6.4			8.3	6.4			8.1	6.3		
32	4.7	4.3	3.9	2.7	7.8	6.0	4.5		7.9	6.1			7.8	6.0		
34	4.3	4.0	3.7	2.7	7.3	5.7	4.4		7.5	5.8	4.4		7.4	5.7	4.4	
36	4.0	3.8	3.6	2.7	6.9	5.4	4.2	2.8	7.0	5.5	4.2		7.0	5.5	4.2	
38	3.7	3.5	3.4	2.6	6.5	5.2	4.1	2.7	6.7	5.2	4.1	2.7	6.7	5.2	4.1	2.7
40	3.5	3.4	3.3	2.6	6.1	4.9	4.0	2.7	6.3	5.0	4.0	2.7	6.3	5.0	4.0	2.7
42	3.3	3.2	3.2		5.8	4.7	3.9		6.0	4.8	3.9	2.7	6.0	4.8	3.9	2.7
44	3.2	3.1			5.4	4.5	3.8		5.7	4.6	3.8	2.7	5.7	4.6	3.8	2.7
46					5.1	4.3	3.7		5.4	4.4	3.7		5.5	4.4	3.7	2.6
48					4.9	4.1	3.6		5.1	4.2	3.6		5.2	4.3	3.7	
50					4.6	3.9	3.5		4.9	4.1	3.6		5.0	4.1	3.6	
52					4.4	3.8	3.5		4.6	3.9	3.5		4.8	3.9	3.5	
54					4.2	3.6	3.4		4.4	3.8	3.4		4.5	3.8	3.5	
56					4.0	3.5	3.3		4.2	3.6	3.4		4.3	3.7	3.4	
58					3.8	3.4			4.0	3.5	3.3		3.9	3.6	3.3	
60					3.6	3.3			3.9	3.4			3.7	3.5	3.3	
62					3.5	3.2			3.7	3.3			3.4	3.4	3.3	
64					3.4	3.2			3.6	3.3			3.1	3.3		
66					3.3				3.4	3.2			2.9	3.1		
68					3.2				3.3	3.1			2.6	2.9		
70									3.1				2.4	2.6		
72									3.0				2.2	2.4		
74									2.6				2.0	2.2		
76													1.9			
78													1.7			

メインブーム長さ ジブ長さ 作業半径(m)	55.5m+2.5m 30m				60.5m+2.5m 30m				65.6m+2.5m 30m			
	0°	20°	40°	60°	0°	20°	40°	60°	0°	20°	40°	60°
18	9.6											
20	9.4				7.8							
22	9.0				7.7					5.9		
24	8.7				7.5					5.8		
26	8.3				7.4					5.7		
28	8.0				7.1					5.5		
30	7.7	6.0			6.8					5.3		
32	7.4	5.8			6.5	5.4				5.1		
34	7.0	5.5			6.2	5.2				4.9	4.2	
36	6.7	5.3	4.2		5.9	5.0				4.6	4.1	
38	6.4	5.1	4.1		5.6	4.9				4.5	3.9	
40	6.1	4.9	4.0	2.7	5.3	4.7	3.9			4.3	3.7	
42	5.8	4.7	3.9	2.7	5.0	4.5	3.8	2.6		4.1	3.6	3.2
44	5.5	4.5	3.8	2.6	4.7	4.4	3.7	2.6		3.9	3.5	3.1
46	5.2	4.4	3.7	2.6	4.4	4.2	3.6	2.6		3.7	3.4	3.1
48	4.9	4.2	3.6	2.6	4.1	4.1	3.6	2.6		3.4	3.3	3.0
50	4.5	4.1	3.6		3.8	3.9	3.5	2.6		3.2	3.2	2.9
52	4.2	3.9	3.5		3.5	3.8	3.4			3.0	3.0	2.8
54	3.9	3.8	3.4		3.2	3.6	3.4			2.7	2.9	2.8
56	3.6	3.7	3.4		3.0	3.4	3.3			2.5	2.8	2.7
58	3.3	3.5	3.3		2.7	3.2	3.3			2.3	2.7	2.6
60	3.0	3.3	3.3		2.4	2.9	3.2			2.0	2.5	2.6
62	2.7	3.1	3.2		2.2	2.7	3.0			1.8	2.3	2.5
64	2.5	2.9	3.1		2.0	2.4	2.7			1.6	2.1	2.3
66	2.2	2.6			1.7	2.2	2.5			1.4	1.8	2.1
68	2.0	2.3			1.5	1.9	2.2				1.6	1.9
70	1.8	2.1			1.3	1.7					1.4	1.7
72	1.6	1.8				1.4						1.4
74	1.4	1.6				1.2						
76	1.2	1.4										
78		1.2										

51505/25/45/65

# 固定式ジブ定格総荷重表 TF

# LTM 1400NX



14.9m-70m



0°/20°/40°/60°  
36m

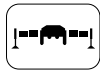

8.9m x 8.53m



360°



100t

メイン長さ ジブ長さ 角度 (m)	14.9m+2.5m 36m				40.3m+2.5m 36m				45.3m+2.5m 36m				50.4m+2.5m 36m				55.5m+2.5m 36m			
	0°	20°	40°	60°	0°	20°	40°	60°	0°	20°	40°	60°	0°	20°	40°	60°	0°	20°	40°	60°
9	10.9																			
10	10.6																			
11	10.2																			
12	9.7																			
13	9.3																			
14	9.0				10.9															
16	8.3				10.3				9.8											
18	7.6				9.7				9.3				8.7							
20	7.0				9.2				8.8				8.3							
22	6.4	5.4			8.7				8.4				7.9							
24	5.8	5.0			8.2				8.0				7.6							
26	5.3	4.6			7.8				7.6				7.3							
28	4.8	4.2			7.4	5.3			7.3				6.9							
30	4.4	3.9			7.0	5.0			6.9	5.0			6.6							
32	4.0	3.7	3.0		6.5	4.8			6.5	4.8			6.3	4.7						
34	3.7	3.4	2.9		6.1	4.5			6.2	4.5			6.0	4.4						
36	3.4	3.2	2.7		5.7	4.3	3.1		5.8	4.3			5.8	4.2						
38	3.2	3.0	2.6	1.5	5.4	4.1	3.0		5.5	4.1	3.0		5.5	4.0						
40	3.0	2.8	2.5	1.5	5.1	3.9	2.9		5.2	3.9	2.9		5.2	3.9	2.9					
42	2.8	2.6	2.4	1.4	4.8	3.7	2.8	1.7	4.9	3.7	2.8		4.9	3.7	2.8					
44	2.6	2.5	2.4	1.4	4.5	3.5	2.8	1.6	4.7	3.6	2.8	1.6	4.7	3.6	2.8	1.6				
46	2.5	2.4	2.3	1.4	4.2	3.4	2.7	1.6	4.4	3.4	2.7	1.6	4.4	3.4	2.7	1.6				
48	2.3	2.3	2.3		4.0	3.3	2.6		4.1	3.3	2.6	1.6	4.2	3.3	2.6	1.6				
50	2.2	2.2			3.8	3.1	2.5		3.9	3.2	2.6	1.6	4.0	3.2	2.6	1.6				
52					3.6	3.0	2.5		3.7	3.1	2.5		3.8	3.1	2.5	1.6				
54					3.4	2.9	2.4		3.5	3.0	2.5		3.6	3.0	2.5					
56					3.2	2.8	2.4		3.4	2.9	2.4		3.5	2.9	2.4					
58					3.1	2.7	2.4		3.2	2.8	2.4		3.3	2.8	2.4					
60					2.9	2.6	2.3		3.1	2.7	2.4		3.2	2.7	2.4					
62					2.8	2.5	2.3		3.0	2.6	2.3		3.0	2.6	2.3					
64					2.7	2.4			2.8	2.5	2.3		2.8	2.6	2.3					
66					2.6	2.3			2.7	2.4			2.7	2.5	2.3					
68					2.5	2.3			2.6	2.4			2.5	2.4	2.3					
70					2.4	2.2			2.5	2.3			2.2	2.3						
72					2.3				2.4	2.3			2.0	2.3						
74					2.2				2.4	2.2			1.8	2.1						
76									2.3				1.6	1.9						
78									2.2				1.4	1.6						
80									1.9				1.3	1.4						

メイン長さ ジブ長さ 角度 (m)	59.0m+2.5m 36m				60.5m+2.5m 36m				64.0m+2.5m 36m				65.6m+2.5m 36m				69.1m+2.5m 36m				70.0m+2.5m 36m
	0°	20°	40°	60°	0°	20°	40°	60°	0°	20°	40°	60°	0°	20°	40°	60°	0°	20°	40°	60°	0°
22	5.1				6.2																
24	4.9				6.1				4.4				4.3				2.9				2.5
26	4.7				5.9				4.4				4.3				2.9				2.5
28	4.5				5.8				4.2				4.2				2.9				2.5
30	4.3				5.6				4.1				4.1				2.9				2.5
32	4.0				5.4				3.8				4.0				2.8				2.5
34	3.8				5.2				3.6				3.9				2.8				2.5
36	3.5	3.1			5.0	3.8			3.3				3.8				2.7				2.4
38	3.3	3.0			4.8	3.7			3.1	2.9			3.6	3.1			2.6				2.4
40	3.0	2.8			4.6	3.5			2.9	2.8			3.5	3.0			2.5	2.7			2.3
42	2.7	2.7			4.3	3.4			2.6	2.7			3.3	2.9			2.4	2.6			2.2
44	2.5	2.6			4.1	3.3	2.7		2.4	2.6			3.2	2.8			2.2	2.5			2.2
46	2.2	2.5	2.2		3.9	3.2	2.6		2.2	2.5			3.0	2.7			2.0	2.4			1.9
48	1.9	2.4	2.1		3.6	3.1	2.6	1.6	2.0	2.4	2.1		2.9	2.6			1.7	2.3			1.7
50	1.6	2.3	2.0	1.6	3.3	3.0	2.5	1.6	1.7	2.2	2.0		2.7	2.5	2.2		1.5	2.1			1.4
52	1.3	2.1	2.0	1.6	3.1	3.0	2.5	1.6	1.4	2.1	2.0	1.6	2.5	2.4	2.1	1.6	1.3	1.9	2.0		1.2
54		1.9	1.9	1.6	2.9	2.9	2.4	1.6	1.2	1.9	1.9	1.6	2.3	2.3	2.1	1.6		1.7	1.9	1.6	
56		1.6	1.9		2.6	2.8	2.4	1.6		1.7	1.9	1.6	2.1	2.2	2.0	1.6		1.5	1.8	1.6	
58		1.3	1.8		2.4	2.7	2.4			1.4	1.8		2.0	2.2	2.0	1.6		1.3	1.7	1.6	
60			1.6		2.1	2.6	2.3			1.7	1.7		1.8	2.0	1.9				1.6		
62			1.4		1.9	2.5	2.3			1.5	1.5		1.5	1.9	1.9				1.4		
64					1.7	2.2	2.3			1.2	1.2		1.3	1.8	1.8						
66					1.5	2.0	2.2						1.7	1.7	1.8						
68					1.2	1.8	2.1						1.5	1.7							
70						1.6	1.9						1.2	1.6							
72						1.3	1.7							1.4							
74							1.4							1.2							
76																					
78																					
80																					

51605/25/45/65

# 固定式ジブ定格総荷重表 TF

# LTM 1400NX



14.9m-69.1m



0°/20°/40°  
42m

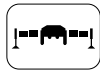

8.9m x 8.53m



360°



100t

メインブーム長さ ジブ長さ 作業半径(m)	14.9m+2.5m 42m			40.3m+2.5m 42m			45.3m+2.5m 42m			50.4m+2.5m 42m			55.5m+2.5m 42m		
	角度			角度			角度			角度			角度		
	0°	20°	40°	0°	20°	40°	0°	20°	40°	0°	20°	40°	0°	20°	40°
10	8.5														
11	8.3														
12	8.0														
13	7.7														
14	7.4														
16	6.8				8.3										
18	6.3				7.8			7.5							
20	5.9				7.4			7.1			6.6				
22	5.4				7.0			6.7			6.3				
24	5.0				6.7			6.4			6.0			5.8	
26	4.6	3.8			6.3			6.1			5.8			5.5	
28	4.2	3.5			6.0			5.8			5.5			5.3	
30	3.8	3.3			5.7			5.5			5.3			5.1	
32	3.5	3.0			5.4	3.8		5.3	3.7		5.1			4.9	
34	3.2	2.8			5.0	3.6		5.0	3.5		4.8	3.4		4.7	
36	3.0	2.6	2.1		4.8	3.4		4.7	3.4		4.6	3.3		4.5	
38	2.8	2.5	1.9		4.5	3.2		4.5	3.2		4.4	3.1		4.4	3.1
40	2.6	2.3	1.8		4.2	3.1		4.3	3.1		4.2	3.0		4.2	3.0
42	2.4	2.2	1.7		4.0	2.9	2.1	4.0	2.9		4.0	2.9		4.0	2.9
44	2.2	2.0	1.6		3.7	2.8	2.1	3.8	2.8	2.1	3.8	2.8	2.0	3.6	2.7
46	2.1	1.9	1.5		3.5	2.7	2.0	3.6	2.7	2.0	3.6	2.7	2.0	3.5	2.6
48	1.9	1.8	1.4		3.3	2.6	1.9	3.4	2.6	1.9	3.4	2.6	1.9	3.3	2.5
50	1.8	1.7	1.4		3.1	2.4	1.8	3.2	2.5	1.9	3.3	2.5	1.9	3.2	2.4
52	1.7	1.6	1.4		3.0	2.3	1.8	3.1	2.4	1.8	3.1	2.4	1.8	3.0	2.3
54	1.6	1.5	1.4		2.8	2.3	1.7	2.9	2.3	1.7	3.0	2.3	1.8	2.9	2.2
56	1.5	1.5			2.7	2.2	1.7	2.8	2.2	1.7	2.8	2.2	1.7	2.7	2.2
58					2.6	2.1	1.6	2.7	2.1	1.7	2.7	2.1	1.7	2.6	2.1
60					2.4	2.0	1.6	2.5	2.0	1.6	2.6	2.1	1.6	2.4	2.0
62					2.3	1.9	1.6	2.4	2.0	1.6	2.5	2.0	1.6	2.2	2.0
64					2.2	1.9	1.6	2.3	1.9	1.6	2.4	1.9	1.6	2.0	1.9
66					2.1	1.8	1.5	2.2	1.8	1.5	2.2	1.9	1.5	1.8	1.8
68					2.0	1.7	1.5	2.1	1.8	1.5	2.1	1.8	1.5	1.6	1.8
70					1.9	1.7	1.5	2.0	1.7	1.5	2.0	1.8	1.5	1.4	1.7
72					1.8	1.6	1.5	1.9	1.7	1.5	1.8	1.7	1.5	1.6	1.6
74					1.7	1.6	1.5	1.8	1.6	1.5	1.6	1.7	1.5	1.5	1.5
76					1.6	1.5	1.5	1.8	1.6	1.5	1.4	1.6	1.5	1.3	1.5
78					1.6	1.5	1.5	1.7	1.5	1.5	1.2	1.5	1.5		
80					1.5	1.5	1.5	1.6	1.5	1.5		1.4	1.4		
82								1.6	1.5	1.5		1.2	1.2		
84								1.5	1.5	1.5					

メインブーム長さ ジブ長さ 作業半径(m)	59.0m+2.5m 42m		60.5m+2.5m 42m			64.0m+2.5m 42m		65.6m+2.5m 42m		69.1m+2.5m 42m	
	角度		角度			角度		角度		角度	
	0°	20°	0°	20°	40°	0°	20°	0°	20°	0°	20°
24	3.9		4.9								
26	3.7		4.7								
28	3.5		4.6								
30	3.4		4.4								
32	3.2		4.2								
34	3.1		4.1								
36	2.9		3.9								
38	2.7		3.8								
40	2.5		3.6	2.7							
42	2.3	2.1	3.5	2.6							
44	2.1	2.0	3.4	2.6							
46	1.8	1.9	3.2	2.5							
48	1.5	1.8	3.1	2.4							
50	1.2	1.7	2.9	2.3							
52		1.6	2.7	2.2	1.7						
54		1.5	2.5	2.2	1.7						
56		1.3	2.3	2.1	1.7						
58			2.1	2.0	1.6						
60			1.9	2.0	1.6						
62			1.7	1.9	1.6						
64			1.5	1.9	1.5						
66			1.2	1.8	1.5						
68				1.6	1.5						
70				1.4	1.5						
72				1.2	1.5						
74					1.4						
76					1.2						

51705/25/45

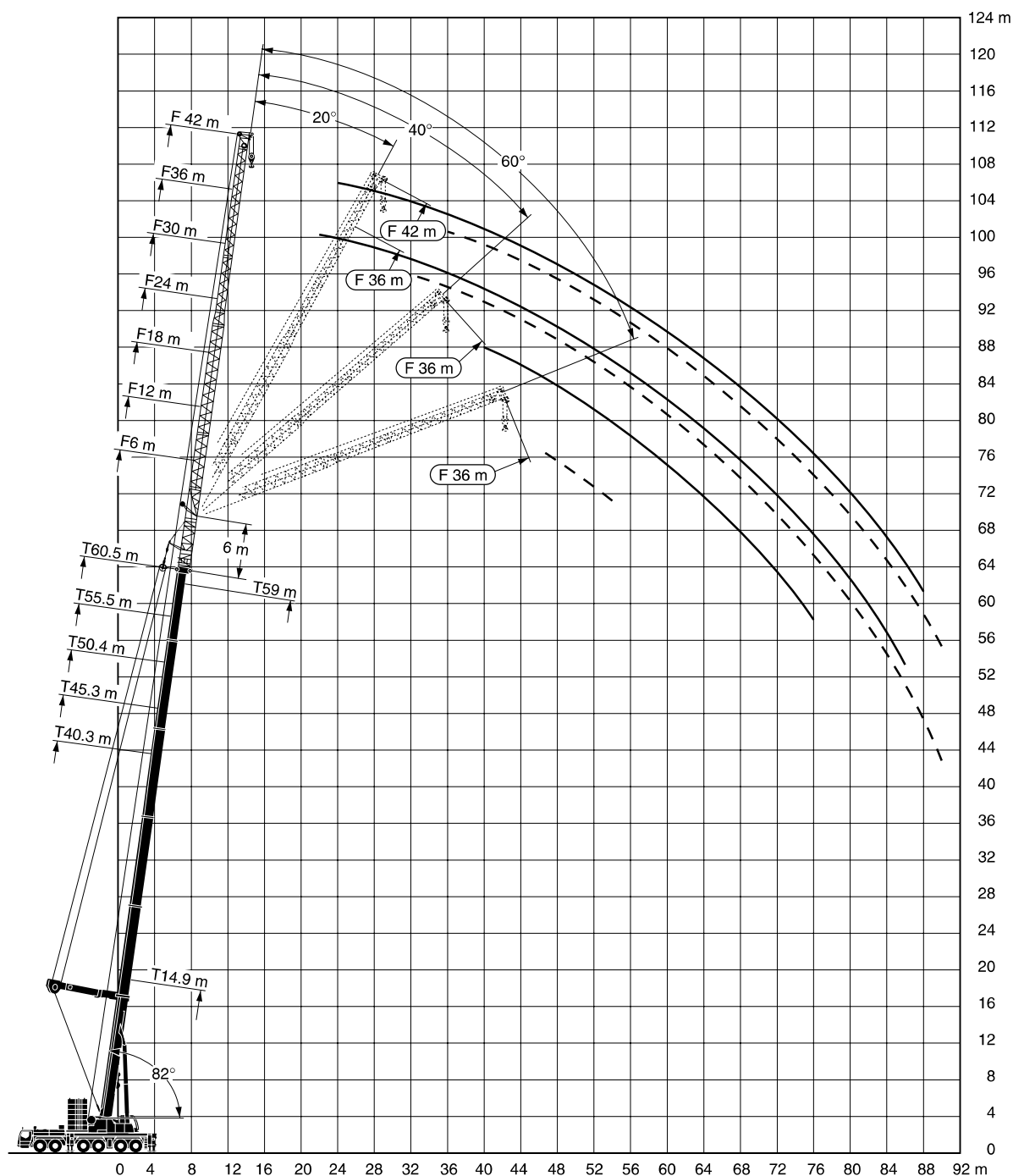

**注意**

- 1 定格総荷重はフックブロック、玉掛ワイヤー等の自重を含みます。  
また、下記の条件が考慮されていないのでクレーンの操作には充分気をつけてください。
  - ① 地盤の強度、地震による影響
  - ② 作業速度に応じた動荷重および台風または強風による影響等
- 2 本機は水平に設置して、クレーン作業を行ってください。
- 3 作業半径は、クレーンの旋回中心から荷重の重心までの水平距離です。
- 4 メインブームの定格総荷重は補助ジブを取り除いた状態での値です。
- 5 メインブーム70m仕様で200トンを超える定格総荷重の場合は、特殊吊装置が必要です。

# 固定式ジブ(ガイ、エクステンダー仕様) 定格総荷重表 TYVEF

# LTM 1400NX



メイン長さ ジブ長さ 角度 (m)	40.3m+6m				45.3m+6m				50.4m+6m				55.5m+6m				60.5m+6m				65.6m+6m							
	6m				6m				6m				6m				6m				6m							
	0°	20°	40°	60°	0°	20°	40°	60°	0°	20°	40°	60°	0°	20°	40°	60°	0°	20°	40°	60°	0°	20°	40°	60°	0°	20°	40°	60°
10	57.8				55.4					48.2																		
11	57.8				55.1					50.0																		
12	57.8	37.7			54.4	38.0				50.0																		
13	56.8	37.1	28.7	25.4	53.5	37.6	29.0			49.6	37.7																	
14	54.7	36.4	28.4	25.4	52.4	37.1	28.7			48.8	37.4	28.8																
16	51.0	34.9	27.9	25.3	48.6	35.8	28.1	25.3		46.3	36.3	28.3	25.3															
18	47.2	33.6	27.4	25.2	44.2	34.6	27.7	25.2	25.4	43.5	35.1	27.8	25.2	40.3	35.6	27.9	25.2	35.7	34.9	28.4	25.5	31.4						
20	43.4	32.5	27.0		40.6	33.4	27.2	25.1		40.1	34.0	27.4	25.1	37.4	34.5	27.6	25.1	34.4	34.0	28.0	25.5	30.0	30.2	27.9	25.4			
22	39.8	31.5	26.6		37.5	32.4	26.9			37.1	33.0	27.1	24.9	34.6	33.4	27.2	25.0	32.3	32.5	27.7	25.5	29.1	29.3	27.5	25.4			
24	36.5	30.5	26.3		34.6	31.5	26.6			34.6	32.0	26.7																
26	33.3	29.7	26.1		31.9	30.6	26.3			32.1	31.0	26.4																
28	29.9	28.9	25.9		29.4	29.7	26.1			29.8	29.8	26.2																
30	27.0	27.7	25.8		26.8	27.6	25.9			27.8	28.0	25.9																
32	24.5	25.1	25.3		24.3	25.0	25.3			25.6	16.1	25.7																
34	22.2	22.8			22.0	22.7	23.0			23.5	24.0	24.4																
36	20.1	20.7			19.9	20.6	20.9			21.5	22.0	22.3																
38	18.3	18.8			18.1	18.7				19.7	20.2	20.4																
40	16.5	17.0			16.3	16.9				18.0	18.5	18.7																
42	14.9	15.3			14.8	15.3				16.5	16.9																	
44	13.0				13.3	13.7				15.1	15.5																	
46	10.4				12.0	12.4				13.8	14.1																	
48	7.1				10.6					12.6	12.8																	
50					8.5					11.4	11.7																	
52					6.0					10.3	10.6																	
54					2.6					8.6																		
56										6.6																		
58										4.1																		
60																												
62																												
64																												
66																												
68																												

\* 60°の時のカウンターウエイトは100t

61101/61121/61141/61165

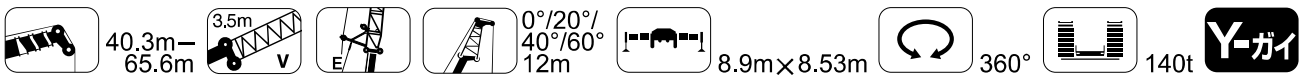

メイン長さ ジブ長さ 角度 (m)	40.3m+6m				45.3m+6m				50.4m+6m				55.5m+6m				60.5m+6m				65.6m+6m							
	12m				12m				12m				12m				12m				12m							
	0°	20°	40°	60°	0°	20°	40°	60°	0°	20°	40°	60°	0°	20°	40°	60°	0°	20°	40°	60°	0°	20°	40°	60°	0°	20°	40°	60°
11	38.7				39.4					37.6																		
12	37.2				38.0					36.7																		
13	35.8				36.6					35.5																		
14	34.5	21.7			35.3					35.5																		
16	32.1	20.7			33.1	21.0				33.4	21.2																	
18	30.0	19.8	15.2		31.0	20.2	15.3			31.5	20.4																	
20	28.0	19.0	14.9	11.3	29.3	19.4	15.0	11.3		29.8	19.7	15.0																
22	26.3	18.2	14.5	11.1	27.6	18.7	14.7	11.2		28.3	19.0	14.7	11.2															
24	24.6	17.5	14.2	11.0	26.1	18.0	14.4	11.1		26.9	18.3	14.5	11.1															
26	23.2	16.9	14.0		24.6	17.4	14.1	11.0		25.6	17.7	14.2	11.0															
28	22.0	16.4	13.8		23.3	16.9	13.9			24.3	17.2	14.0	10.9															
30	20.8	15.9	13.6		22.2	16.3	13.7			23.2	16.7	13.8																
32	19.8	15.4	13.4		21.1	15.9	13.5			22.1	16.2	13.6																
34	18.9	15.0	13.3		20.1	15.5	13.4			21.1	15.8	13.5																
36	18.1	14.6	13.2		19.3	15.1	13.3			20.0	15.4	13.3																
38	17.3	14.3	13.1		18.4	14.7	13.2			19.1	15.1	13.2																
40	16.6	14.0			17.3	14.4	13.1			18.3	14.8	13.1																
42	15.7	13.8			15.8	14.1	13.0			17.1	14.5	13.0																
44	14.6	13.5			14.3	13.9				15.7	14.2	13.0																
46	13.2	13.3			13.0	13.4				14.5	13.8	12.9																
48	12.0	12.6			11.8	12.5				13.2	13.5																	
50	10.2				10.7	11.3				12.1	12.6																	
52	7.9				9.6	10.2				11.1	11.6																	
54	5.1				8.2					10.1	10.6																	
56					6.4					9.2	9.6																	
58					4.2					8.0	8.7																	
60										6.6																		
62										4.8																		
64																												
66																												
68																												
70																												
72																												

61201/61221/61241/61261

# 固定式ジブ (ガイ、エクセンダー仕様) 定格総荷重表 TYVEF

# LTM 1400NX

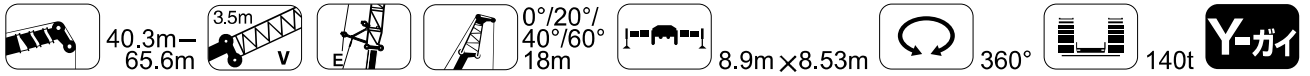

メイン長さ ジブ長さ 角度 (m)	40.3m+6m 18m				45.3m+6m 18m				50.4m+6m 18m				55.5m+6m 18m				60.5m+6m 18m				65.6m+6m 18m			
	0°	20°	40°	60°	0°	20°	40°	60°	0°	20°	40°	60°	0°	20°	40°	60°	0°	20°	40°	60°	0°	20°	40°	60°
11	28.8																							
12	27.6				28.0																			
13	26.5				26.9					26.8														
14	25.5				26.0					26.0				25.8										
16	23.7				24.2					24.4				24.4										
18	22.1	14.4			22.7	14.6				22.9				23.1										
20	20.8	13.7			21.3	13.9				21.7	14.1			21.8	14.2							22.2		
22	19.5	13.1	9.9		20.2	13.4	10.0			20.5	13.5			20.8	13.6						20.5	13.9		
24	18.3	12.5	9.6	6.5	19.1	12.8	9.7			19.5	13.0	9.7		19.7	13.2	9.8					19.6	13.4		
26	17.2	12.0	9.3	6.4	18.0	12.3	9.4	6.4		18.5	12.5	9.5	6.4	18.9	12.7	9.5					18.8	13.0	9.8	
28	16.2	11.6	9.1	6.3	17.1	11.9	9.2	6.3		17.6	12.1	9.3	6.3	18.0	12.3	9.3	6.3				18.0	12.6	9.6	6.6
30	15.3	11.2	8.8	6.2	16.2	11.5	9.0	6.2		16.8	11.7	9.0	6.2	17.2	11.9	9.1	6.2				17.3	12.2	9.5	6.5
32	14.5	10.8	8.6		15.4	11.1	8.8	6.2		16.0	11.3	8.8	6.2	16.5	11.6	8.9	6.2				16.6	11.8	9.3	6.4
34	13.7	10.4	8.4		14.6	10.8	8.6			15.3	11.0	8.7		15.8	11.2	8.8	6.1				16.0	11.5	9.1	6.4
36	13.1	10.1	8.3		13.9	10.4	8.4			14.6	10.7	8.5		15.2	10.9	8.6					15.4	11.2	9.0	6.4
38	12.5	9.8	8.1		13.3	10.1	8.2			13.9	10.4	8.3		14.6	10.6	8.4					14.8	10.9	8.8	
40	11.9	9.5	8.0		12.7	9.8	8.1			13.3	10.1	8.2		14.0	10.3	8.3					14.3	10.7	8.7	
42	11.4	9.2	7.9		12.1	9.6	8.0			12.8	9.8	8.1		13.4	10.1	8.2					13.8	10.4	8.6	
44	10.9	9.0	7.8		11.7	9.3	7.9			12.3	9.6	8.0		12.9	9.8	8.0					13.3	10.2	8.4	
46	10.5	8.8			11.2	9.1	7.8			11.8	9.3	7.9		12.4	9.6	7.9					12.6	10.0	8.3	
48	10.0	8.5			10.8	8.8	7.7			11.4	9.1	7.8		11.8	9.4	7.9					12.1	9.8	8.2	
50	9.6	8.4			10.4	8.6				10.9	8.9	7.7		11.4	9.1	7.8					11.4	9.6	8.1	
52	9.2	8.2			10.0	8.4				10.5	8.7			11.0	8.9	7.7					10.5	9.4	8.1	
54	8.8	8.1			9.4	8.3				10.1	8.5			10.2	8.7	7.7					9.6	9.2	8.0	
56	8.0				8.7	8.1				9.8	8.3			9.3	8.6						8.8	9.0	8.0	
58	6.1				7.7	8.0				9.1	8.2			8.6	8.4						8.1	8.8	7.9	
60	3.6				6.4					8.3	8.0			7.8	8.1						7.3	8.3		
62					4.8					7.5	7.9			7.1	7.6						6.6	7.5		
64					3.0					6.3	6.1			6.4	7.0						6.0	6.8		
66										5.0				5.7	6.3						5.3	6.1		
68										3.6				4.7	5.6						4.7	5.5		
70										1.8				3.7							4.1	4.8		
72														2.5							3.3	4.2		
74																					2.4	3.4		
76																								
78																								
80																								
82																								

60301/61321/61341/61361



メイン長さ ジブ長さ 角度 (m)	40.3m+6m 24m				45.3m+6m 24m				50.4m+6m 24m				55.5m+6m 24m				60.5m+6m 24m				65.6m+6m 24m			
	0°	20°	40°	60°	0°	20°	40°	60°	0°	20°	40°	60°	0°	20°	40°	60°	0°	20°	40°	60°	0°	20°	40°	60°
13	20.9				21.1																			
14	20.1				20.4					20.1														
16	18.8				19.1					19.1				19.0										
18	17.6				17.9					18.0				18.0										
20	16.4	10.8			16.9					17.0				17.1								16.8		
22	15.5	10.3			15.9	10.5				16.1	10.5			16.2							16.0			
24	14.6	9.8			15.0	10.0				15.2	10.1			15.4	10.2						15.3			
26	13.7	9.4	6.7		14.2	9.6				14.5	9.7			14.7	9.8						14.6	9.8		
28	13.0	9.0	6.5		13.5	9.2	6.6			13.8	9.3	6.6		14.0	9.5						14.0	9.5		
30	12.2	8.6	6.3	4.0	12.8	8.8	6.4			13.1	9.0	6.4		13.4	9.1	6.4				13.4	9.2	6.4		
32	11.6	8.2	6.1	4.0	12.2	8.5	6.2			12.5	8.6	6.2	4.0	12.8	8.8	6.3				12.9	8.8	6.3		
34	11.0	7.9	6.0	3.9	11.6	8.1	6.0	3.9		12.0	8.3	6.1	3.9	12.3	8.5	6.1	3.9			12.3	8.6	6.1	3.9	
36	10.3	7.6	5.8	3.9	11.0	7.8	5.9	3.9		11.5	8.0	5.9	3.9	11.8	8.2	6.0	3.9			11.9	8.3	6.0	3.9	
38	9.8	7.3	5.6		10.5	7.5	5.7	3.8		11.0	7.7	5.8	3.8	11.3	7.9	5.9	3.8			11.4	8.0	5.9	3.8	
40	9.3	7.0	5.5		9.9	7.3	5.6			10.5	7.5	5.7	3.8	10.8	7.6	5.7	3.8			11.0	7.7	5.7	3.8	
42	8.9	6.7	5.4		9.5	7.0	5.5			10.0	7.2	5.6		10.4	7.4	5.6				10.6	7.5	5.6	3.8	
44	8.4	6.5	5.3		9.0	6.8	5.4			9.5	7.0	5.4		10.0	7.2	5.5				10.2	7.3	5.5		
46	8.0	6.3	5.2		8.6	6.6	5.3			9.1	6.7	5.3		9.6	6.9	5.4				9.8	7.1	5.4		
48	7.6	6.1	5.1		8.2	6.4	5.2			8.7	6.6	5.3		9.2	6.7	5.3				9.5	6.9	5.4		
50	7.2	5.9	5.0		7.8	6.2	5.1			8.3	6.4	5.2		8.8	6.6	5.2				9.1	6.7	5.3		
52	6.9	5.8			7.5	6.0	5.0			8.0	6.2	5.1		8.4	6.4	5.2				8.8	6.5	5.2		
54	6.6	5.6			7.1	5.8	5.0			7.7	6.0	5.0		8.1	6.2	5.1				8.4	6.3	5.1		
56	6.3	5.5			6.8	5.7				7.3	5.9	5.0		7.8	6.0	5.0				8.0	6.2	5.1		
58	6.0	5.4			6.5	5.6				7.0	5.7			7.4	5.9	5.0				7.7	6.0	5.0		
60	5.7	5.3			6.3	5.4				6.8	5.6			7.1	5.8	5.0				7.4	5.9	5.0		
62	5.5				6.0	5.3				6.5	5.5			6.8	5.6					6.9	5.8	4.9		
64	4.5				5.6	5.3				6.2	5.4			6.6	5.5					6.4	5.6	4.9		
66	2.5				4.8					6.0	5.3			6.2	5.4					5.8	5.5			
68					3.5					5.6	5.2			5.6	5.3					5.2	5.4			
70					1.9					4.9	4.4			5.0	5.2					4.6	5.2			
72										3.7				4.3	5.1					4.1	4.8			
74										2.5				3.5	4.5					3.5	4.3			
76														2.5						2.9	3.7			
78																				2.2	3.1			
80																				1.2	2.4			
82																								

61401/61421/61441/61461

# 固定式ジブ(ガイ、エクステンダー仕様) 定格総荷重表 TYVEF

# LTM 1400NX

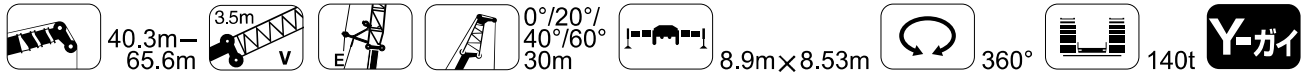

メイン長さ ジブ長さ 角度 (m)	40.3m+6m 30m				45.3m+6m 30m				50.4m+6m 30m				55.5m+6m 30m				60.5m+6m 30m				65.6m+6m 30m			
	0°	20°	40°	60°	0°	20°	40°	60°	0°	20°	40°	60°	0°	20°	40°	60°	0°	20°	40°	60°	0°	20°	40°	60°
13	16.3																							
14	15.7																							
16	14.7																							
18	13.7																							
20	12.9																							
22	12.1																							
24	11.5	7.7																						
26	10.8	7.3																						
28	10.2	6.9																						
30	9.7	6.6	4.6																					
32	9.2	6.3	4.4																					
34	8.7	6.0	4.3																					
36	8.2	5.7	4.1	2.6																				
38	7.8	5.5	4.0	2.6	8.6	5.9	4.1	2.6	8.8	6.0	4.2													
40	7.3	5.2	3.9	2.5	8.2	5.6	4.0	2.6	8.4	5.7	4.0	2.6												
42	6.9	5.0	3.7	2.5	7.7	5.4	3.9	2.5	8.0	5.5	3.9	2.5	8.3	5.6	4.0	2.5	8.3	5.7	4.0	2.5	8.2	5.6	3.9	
44	6.5	4.8	3.6		7.3	5.2	3.8	2.5	7.7	5.3	3.8	2.5	7.9	5.4	3.9	2.5	8.0	5.5	3.9	2.5	7.9	5.5	3.8	2.4
46	6.2	4.6	3.6		7.0	5.0	3.7	2.5	7.3	5.1	3.7	2.5	7.6	5.2	3.8	2.5	7.7	5.3	3.8	2.4	7.7	5.3	3.7	2.4
48	5.8	4.5	3.5		6.6	4.8	3.6		7.0	4.9	3.7	2.5	7.3	5.1	3.7	2.4	7.4	5.1	3.7	2.4	7.4	5.1	3.7	2.4
50	5.5	4.3	3.4		6.3	4.6	3.5		6.6	4.8	3.6		7.0	4.9	3.6		7.1	5.0	3.6		7.1	5.0	3.6	2.4
52	5.3	4.1	3.4		6.0	4.5	3.5		6.3	4.6	3.5		6.7	4.7	3.5		6.8	4.8	3.6		6.9	4.8	3.5	2.4
54	5.0	4.0	3.3		5.7	4.3	3.4		6.0	4.4	3.4		6.4	4.6	3.5		6.6	4.6	3.5		6.6	4.7	3.5	2.4
56	4.7	3.9	3.3		5.4	4.2	3.4		5.7	4.3	3.4		6.1	4.4	3.4		6.3	4.5	3.4		6.4	4.5	3.4	
58	4.5	3.8			5.1	4.0	3.3		5.5	4.2	3.4		5.8	4.3	3.4		6.1	4.4	3.4		6.2	4.4	3.4	
60	4.3	3.7			4.9	3.9	3.3		5.3	4.0	3.3		5.6	4.2	3.3		5.8	4.2	3.3		6.0	4.3	3.4	
62	4.1	3.6			4.7	3.8	3.3		5.0	3.9	3.3		5.4	4.1	3.3		5.6	4.1	3.3		5.7	4.2	3.3	
64	3.9	3.5			4.5	3.7			4.8	3.8	3.2		5.1	3.9	3.3		5.4	4.0	3.3		5.5	4.1	3.3	
66	3.7	3.5			4.3	3.6			4.6	3.7			4.9	3.8	3.2		5.2	3.9	3.2		5.3	4.0	3.2	
68	3.6				4.1	3.5			4.4	3.6			4.7	3.8	3.2		4.9	3.8	3.2		5.0	3.9	3.2	
70	3.1				3.9	3.5			4.2	3.6			4.5	3.7			4.7	3.7	3.2		4.6	3.8	3.2	
72	1.5				3.7	3.4			4.0	3.5			4.3	3.6			4.5	3.7	3.2		4.1	3.7	3.2	
74					3.3				3.9	3.4			4.1	3.5			4.3	3.6			3.6	3.6	3.2	
76					2.3				3.7	3.4			4.0	3.5			3.9	3.5			3.2	3.5	3.2	
78									3.4	3.3			3.8	3.4			3.4	3.4			2.7	3.4		
80									2.6				3.1	3.4			2.9	3.4			2.3	3.2		
82									1.4				2.3	3.3			2.4	3.1			1.9	2.8		
84																	1.8	2.8			1.4	2.3		
86																		2.2				1.8		
88																						1.4		
90																								

61501/61521/61541/61561



メイン長さ ジブ長さ 角度 (m)	40.3m+6m 36m				45.3m+6m 36m				50.4m+6m 36m				55.5m+6m 36m				60.5m+6m 36m				65.6m+6m 36m			
	0°	20°	40°	60°	0°	20°	40°	60°	0°	20°	40°	60°	0°	20°	40°	60°	0°	20°	40°	60°	0°	20°	40°	60°
14	12.6																							
16	11.8																							
18	11.0																							
20	10.3																							
22	9.7																							
24	9.2																							
26	8.7	5.8																						
28	8.2	5.5																						
30	7.7	5.2																						
32	7.3	4.9																						
34	6.9	4.6																						
36	6.6	4.4	3.1																					
38	6.2	4.2	2.9																					
40	5.8	4.0	2.8																					
42	5.5	3.8	2.8																					
44	5.2	3.6	2.7	1.5																				
46	4.9	3.4	2.6	1.5																				
48	4.6	3.3	2.5	1.4																				
50	4.3	3.2	2.5																					
52	4.1	3.1	2.4																					
54	3.8	3.0	2.3																					
56	3.6	2.9	2.3																					
58	3.4	2.8	2.3																					
60	3.3	2.7	2.2																					
62	3.1	2.6	2.2																					
64	3.0	2.5																						
66	2.9	2.5																						
68	2.7	2.4																						
70	2.6	2.4																						
72	2.5	2.3																						
74	2.4																							
76	2.2																							
78																								
80																								
82																								
84																								
86																								
88																								
90																								

61601/61621/61641/61661

# 固定式ジブ (ガイ、エクセンダー仕様) 定格総荷重表 TYVEF

# LTM 1400NX

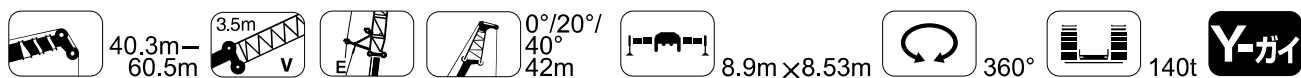

メインブーム長さ ジブ長さ 作業半径(m)	40.3m+6m 42m			45.3m+6m 42m			50.4m+6m 42m			55.5m+6m 42m			60.5m+6m 42m	
	0°	20°	40°	0°	20°	40°	0°	20°	40°	0°	20°	40°	0°	20°
16	9.9													
18	9.3			9.3			9.2			9.1				
20	8.7			8.7			8.7			8.7				
22	8.2			8.2			8.3			8.3			8.0	
24	7.7			7.8			7.8			7.8			7.7	
26	7.3			7.4			7.4			7.4			7.3	
28	6.9			7.0			7.1			7.1			7.0	
30	6.5	4.4		6.6			6.7			6.8			6.7	
32	6.2	4.2		6.3	4.2		6.4	4.3		6.4			6.4	
34	5.9	4.0		6.0	4.0		6.1	4.1		6.2	4.1		6.1	
36	5.6	3.8		5.7	3.8		5.8	3.9		5.9	3.9		5.8	3.9
38	5.3	3.6		5.4	3.6		5.6	3.7		5.6	3.8		5.6	3.8
40	5.0	3.4	2.4	5.2	3.5		5.3	3.5		5.4	3.6		5.4	3.6
42	4.7	3.2	2.3	4.9	3.3	2.3	5.1	3.4	2.3	5.2	3.4		5.2	3.4
44	4.4	3.1	2.2	4.7	3.2	2.2	4.8	3.2	2.2	4.9	3.3	2.3	4.9	3.3
46	4.2	2.9	2.1	4.4	3.0	2.1	4.6	3.1	2.2	4.7	3.2	2.2	4.8	3.2
48	3.9	2.8	2.0	4.2	2.9	2.1	4.4	3.0	2.1	4.5	3.1	2.1	4.6	3.1
50	3.7	2.7	2.0	4.0	2.8	2.0	4.2	2.9	2.0	4.3	2.9	2.1	4.4	3.0
52	3.5	2.6	1.9	3.8	2.7	1.9	4.0	2.8	2.0	4.2	2.8	2.0	4.2	2.9
54	3.3	2.5	1.8	3.6	2.6	1.9	3.8	2.7	1.9	4.0	2.7	1.9	4.0	2.8
56	3.2	2.4	1.8	3.4	2.5	1.8	3.6	2.6	1.9	3.8	2.6	1.9	3.9	2.7
58	3.0	2.3	1.7	3.2	2.4	1.8	3.4	2.5	1.8	3.6	2.5	1.8	3.7	2.6
60	2.8	2.2	1.7	3.1	2.3	1.7	3.3	2.4	1.8	3.5	2.4	1.8	3.5	2.5
62	2.7	2.1	1.7	2.9	2.2	1.7	3.1	2.3	1.7	3.3	2.4	1.8	3.4	2.4
64	2.5	2.0	1.6	2.8	2.1	1.6	3.0	2.2	1.7	3.1	2.3	1.7	3.3	2.3
66	2.4	2.0	1.6	2.6	2.1	1.6	2.9	2.1	1.6	3.0	2.2	1.7	3.1	2.3
68	2.3	1.9	1.6	2.5	2.0	1.6	2.7	2.1	1.6	2.9	2.1	1.6	3.0	2.2
70	2.2	1.8		2.4	1.9	1.6	2.6	2.0	1.6	2.8	2.1	1.6	2.9	2.1
72	2.1	1.8		2.3	1.9		2.5	1.9	1.6	2.7	2.0	1.6	2.8	2.0
74	2.0	1.7		2.2	1.8		2.4	1.9	1.5	2.5	1.9	1.6	2.7	2.0
76	1.9	1.7		2.1	1.8		2.3	1.8		2.4	1.9	1.5	2.6	1.9
78	1.8			2.0	1.7		2.2	1.8		2.3	1.8	1.5	2.4	1.9
80	1.7			1.9	1.7		2.1	1.7		2.2	1.8		2.3	1.8
82	1.3			1.8	1.6		2.0	1.7		2.1	1.7		2.2	1.8
84				1.6			1.9	1.6		2.0	1.7		2.1	1.7
86							1.8	1.6		2.0	1.7		2.0	1.7
88							1.6			1.7	1.6		1.7	1.7
90										1.3	1.6			1.5
92											1.5			

61701/61721/61741

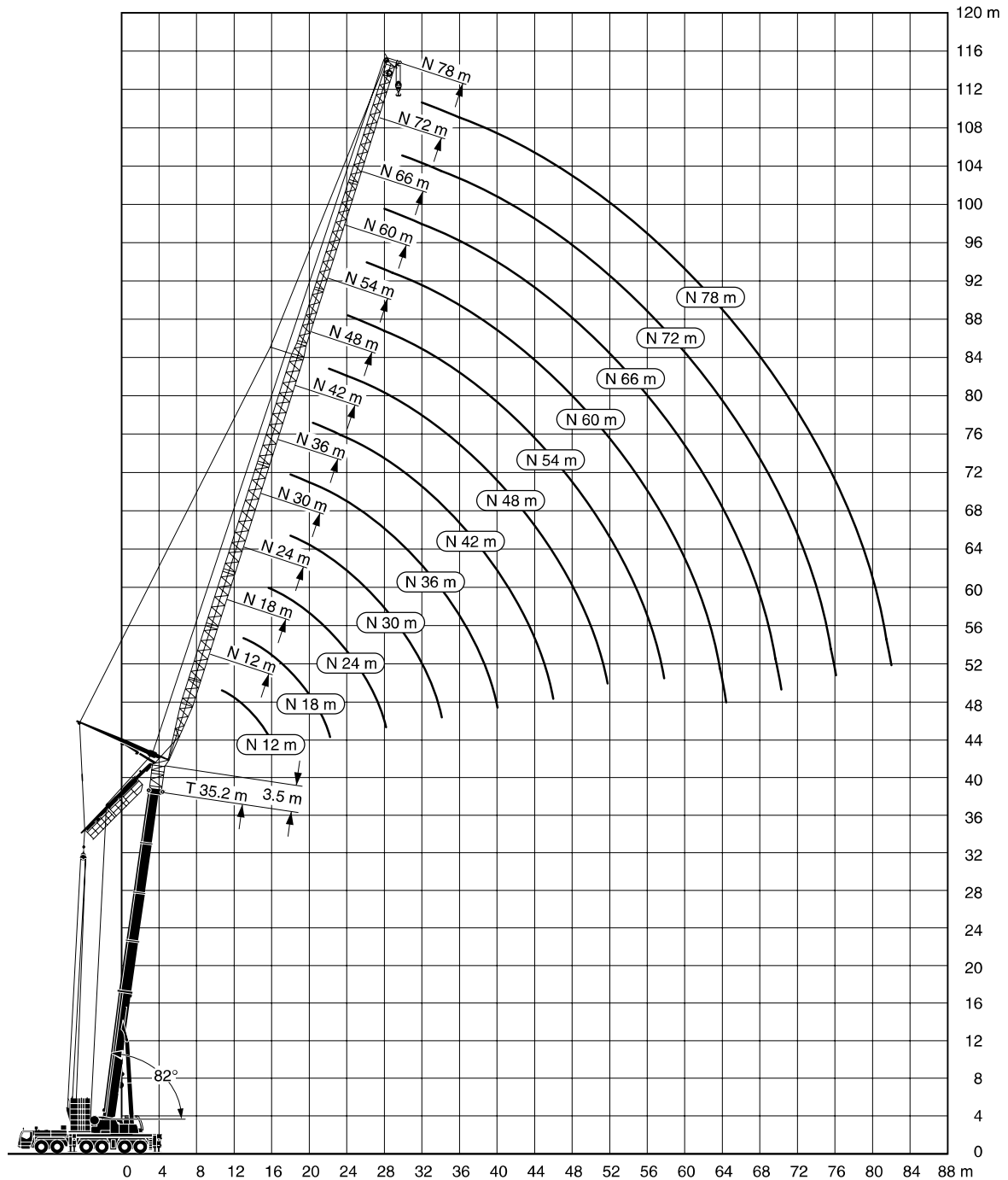

**注意**

- 1 定格総荷重はフックブロック、玉掛ワイヤー等の自重を含みます。  
また、下記の条件が考慮されていないのでクレーンの操作には充分気をつけてください。
  - ① 地盤の強度、地震による影響
  - ② 作業速度に応じた動荷重および台風または強風による影響等
- 2 本機は水平に設置して、クレーン作業を行ってください。
- 3 作業半径は、クレーンの旋回中心から荷重の重心までの水平距離です。
- 4 メインブームの定格総荷重は補助ジブを取り除いた状態での値です。
- 5 メインブーム70m仕様で200トンを超える定格総荷重の場合は、特殊吊装置が必要です。

# 起伏式ジブ定格総荷重表 TN

# LTM 1400NX

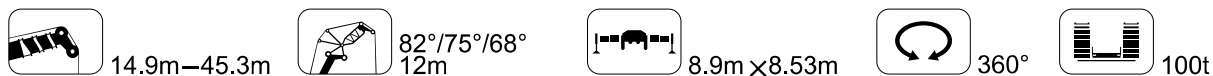

メイン長さ ジブ長さ 角度 (m)	14.9m+3.5m 12m			20.0m+3.5m 12m			25.0m+3.5m 12m			30.1m+3.5m 12m			35.2m+3.5m 12m			40.3m+3.5m 12m			45.3m+3.5m 12m		
	82°	75°	68°	82°	75°	68°	82°	75°	68°	82°	75°	68°	82°	75°	68°	82°	75°	68°	82°	75°	
7	70.8																				
8	70.8			70.8																	
9	70.8			70.8					64.4												
10	69.3			69.9					65.1			53.2									
11	66.0	67.0		68.4					64.9			53.5			44.7						
12	61.5	62.6		65.7	67.8				63.7			53.6			44.7				34.0		
13	55.0	59.4		60.3	65.1				62.9			53.9			44.8				34.0		26.3
14	49.1	56.9	58.1	53.9	62.0				59.4	61.7		54.4			45.0				34.0		26.2
16		50.5	51.8		57.0	56.4			57.3			53.9	51.8		45.8				33.6		26.2
18			49.5			50.2			50.9				49.2								26.2
20						45.0									42.6						
22										43.2			44.1		42.2				28.0		
24										39.2								26.1			22.1
26														37.2							20.8
28															34.0						
																			32.8		
																			30.0		
																				20.7	
																				19.2	

54105

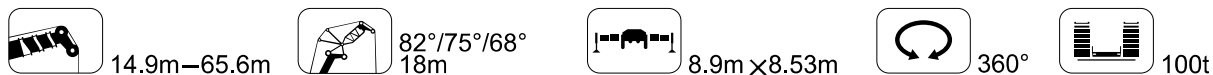

メイン長さ ジブ長さ 角度 (m)	14.9m+3.5m 18m			20.0m+3.5m 18m			25.0m+3.5m 18m			30.1m+3.5m 18m			35.2m+3.5m 18m			40.3m+3.5m 18m			45.3m+3.5m 18m			50.4m+3.5m 18m			55.5m+3.5m 18m		60.5m+3.5m 18m		65.6+3.5 18m	
	82°	75°	68°	82°	75°	68°	82°	75°	68°	82°	75°	68°	82°	75°	68°	82°	75°	68°	82°	75°	68°	82°	75°	68°	82°	75°	82°	75°		
9	59.2																													
10	57.9			55.3																										
11	56.5			54.9			49.2																							
12	55.0			53.8			49.1			41.1																				
13	53.7			52.7			49.1			41.1			34.9																	
14	52.5	52.4		51.7			48.6			41.1			34.9			27.1														
16	50.6	49.1		50.2	49.7		47.5			41.1			34.9			27.0			20.7			15.7								
18	48.2	45.7	46.0	49.6	47.5		46.9	45.7		41.1	39.8		34.9			27.0			20.7			15.6			11.5	8.2				
20	41.0	44.0	42.1	44.1	46.1	44.8	46.5	44.3		41.1	40.0		34.9	33.9		26.9			20.7			15.6			11.5	8.1	5.4			
22		42.3	39.8		42.5	40.7		41.3	38.9	41.1	39.5		34.9	33.8		26.6	24.4		20.7			15.6			11.4	8.1	5.3			
24			38.5			37.2		37.7	35.6		36.5	33.7		33.6			23.2		20.7	18.9		15.6			11.4	8.1	5.3			
26						34.1			32.7		33.5	31.0		32.7			22.0			18.1		14.0			11.4	8.1	5.2			
28									30.2				28.5			27.4	20.9			17.3		13.5			10.2					
30												26.3			25.2			17.6		16.6		12.9			9.8					
32															23.3			16.6			14.0				9.5		7.0			
34																	15.7				13.2			10.1		6.7				
36																						9.5								

54205

# 起伏式ジブ定格総荷重表 TN

# LTM 1400NX



14.9m—65.6m



82°/75°/68°  
24m



8.9m×8.53m



360°



100t

メインブーム長さ ジブ長さ 作業半径(m)	14.9m+3.5m 24m			20.0m+3.5m 24m			25.0m+3.5m 24m			30.1m+3.5m 24m			35.2m+3.5m 24m			40.3m+3.5m 24m			
	82°	75°	68°	82°	75°	68°	82°	75°	68°	82°	75°	68°	82°	75°	68°	82°	75°	68°	
11	46.1																		
12	45.1			42.9															
13	44.2			42.5			38.3												
14	43.3			41.9			38.3			32.5									
16	41.7	41.7		40.6			38.1			32.5			28.0				21.8		
18	40.2	39.8		39.6	39.4		37.3			32.5			28.0				21.7		
20	39.3	38.2		38.8	38.0		36.6	36.2		32.5			28.2				21.6		
22	39.1	36.8	36.6	38.5	36.8		36.3	35.2		32.5	31.6		28.3				21.6		
24	39.1	36.0	34.6	38.5	36.0	35.6	36.3	34.5		32.5	31.2		28.4	27.2			21.6		
26	30.1	35.6	32.9	36.8	35.5	33.9	36.3	34.0	32.4	32.5	30.9		28.4	27.2			21.5	20.0	
28		33.6	32.1		32.8	31.4		31.9	30.0	32.5	30.7	28.2	28.4	27.1			21.3	19.2	
30			30.2			29.1		29.6	27.7		28.5	26.0		27.1	24.8			18.4	
32						27.0			25.7		26.4	24.1		25.6	22.9			17.6	16.0
34									23.8			22.4			21.3			17.0	15.0
36												20.9			19.9				14.2
38															18.6				13.4

メインブーム長さ ジブ長さ 作業半径(m)	45.3m+3.5m 24m			50.4m+3.5m 24m			55.5m+3.5m 24m			60.5m+3.5m 24m			65.6m+3.5m 24m	
	82°	75°	68°	82°	75°	68°	82°	75°	68°	82°	75°	68°	82°	75°
18	16.6			12.2										
20	16.5			12.2			9.0			6.3				
22	16.5			12.2			9.0			6.2			3.4	
24	16.5			12.2			8.9			6.1			3.4	
26	16.5	15.8		12.2			8.9			6.1			3.4	
28	16.5	15.5		12.2			8.9			6.0			3.3	
30	16.5	15.0		12.2	11.2		8.9			6.0			3.3	
32		14.4			10.8			8.0		6.0			3.3	
34		14.0			10.5			7.8			5.3			
36		13.6	11.9		10.2			7.5			5.3			2.7
38			11.2			8.3		7.3			5.2			2.7
40			10.7			7.8					5.1			2.7
42						7.4				5.3				
44									5.0				3.3	
46													3.2	

54305

# 起伏式ジブ定格総荷重表 TN

# LTM 1400NX



14.9m—65.6m

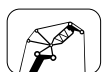

82°/75°/68°  
30m

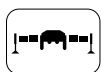

8.9m×8.53m



360°



100t

メインブーム長さ ジブ長さ 作業半径(m)	14.9m+3.5m 30m			20.0m+3.5m 30m			25.0m+3.5m 30m			30.1m+3.5m 30m			35.2m+3.5m 30m			40.3m+3.5m 30m			
	82°	75°	68°	82°	75°	68°	82°	75°	68°	82°	75°	68°	82°	75°	68°	82°	75°	68°	
13	35.7																		
14	35.1			33.2															
16	34.2			32.9			29.8			25.8									
18	33.2			32.2			29.8			25.7			22.3					17.7	
20	32.4	31.9		31.5	31.2		29.5			25.5			22.2					17.6	
22	31.7	30.9		31.0	30.3		29.2	28.7		25.5			22.2					17.5	
24	31.3	30.1	29.8	30.6	29.6		28.8	28.1		25.5	24.8		22.2					17.4	
26	31.2	29.4	28.8	30.5	29.1	28.7	28.7	27.6		25.5	24.8		22.2	21.4				17.4	
28	31.2	29.0	28.0	30.5	28.6	27.9	28.7	27.2	26.9	25.5	24.7		22.2	21.4				17.4	16.7
30	27.9	29.0	27.3	30.5	28.5	27.3	28.7	27.0	26.3	25.5	24.5		22.2	21.4				17.4	16.3
32	20.9	29.0	27.1	25.9	28.2	26.7	28.7	26.9	25.4	25.5	24.4	23.7	22.2	21.4				17.4	15.9
34		24.2	26.0		26.3	24.9		25.4	23.6	25.5	24.3	22.0	22.2	21.4	20.7			17.4	15.4
36			24.2					23.2		23.7	22.0		22.7	20.5				21.4	19.6
38								21.7			20.6		21.2	19.2				20.6	18.4
40											19.3			18.0				17.2	14.1
42														16.9				16.2	11.5
44																		15.2	11.0

メインブーム長さ ジブ長さ 作業半径(m)	45.3m+3.5m 30m			50.4m+3.5m 30m			55.5m+3.5m 30m			60.5m+3.5m 30m			65.6+3.5 30m
	82°	75°	68°	82°	75°	68°	82°	75°	68°	82°	75°	68°	82°
20	13.1			10.1									
22	13.1			10.0			7.1			4.3			
24	13.0			9.9			7.1			4.2			1.8
26	13.0			9.9			7.0			4.1			1.8
28	13.0			9.8			7.0			4.1			1.8
30	13.0	12.6		9.8			6.9			4.0			1.7
32	13.0	12.5		9.8	9.3		6.9			4.0			1.7
34	13.0	12.3		9.8	9.1		6.9	6.3		4.0			1.7
36	13.0	11.9		9.8	8.8		6.9	6.2		4.0	3.4		1.7
38		11.6	10.3		8.6			6.2		4.0	3.4		1.7
40		11.3	9.8		8.3			6.0			3.4		
42		11.1	9.4		8.1	6.7		5.8			3.3		
44			8.9			6.4		5.7	4.4		3.3		
46			8.6			6.1			4.1		3.3		
48						5.8			3.9			2.5	
50									3.7			2.4	
52												2.2	

54405

# 起伏式ジブ定格総荷重表 TN

# LTM 1400NX



14.9m—60.5m



82°/75°/68°  
36m

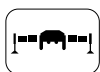

8.9m×8.53m



360°



100t

メインブーム長さ ジブ長さ 作業半径(m)	14.9m+3.5m 36m			20.0m+3.5m 36m			25.0m+3.5m 36m			30.1m+3.5m 36m			35.2m+3.5m 36m		
	角度			角度			角度			角度			角度		
	82°	75°	68°	82°	75°	68°	82°	75°	68°	82°	75°	68°	82°	75°	68°
16	28.0			26.1											
18	27.4			25.9			23.6			20.6			18.1		
20	26.8			25.8			23.4			20.5			17.9		
22	26.2	25.9		25.4			23.3			20.4			17.8		
24	25.7	25.2		25.0	24.6		23.3	22.8		20.3			17.8		
26	25.2	24.6		24.6	24.1		23.2	22.7		20.3	19.7		17.8		
28	24.9	24.1	23.8	24.4	23.6		23.0	22.4		20.3	19.6		17.8	17.2	
30	24.2	23.6	23.1	24.1	23.3	23.0	22.7	22.1		20.3	19.6		17.8	17.2	
32	23.3	23.3	22.6	23.2	22.9	22.4	22.1	21.8	21.5	20.3	19.6		17.8	17.1	
34	22.3	22.8	22.1	22.3	22.8	22.0	21.3	21.6	21.1	20.2	19.6	19.2	17.8	17.1	
36	21.3	22.2	21.9	21.4	22.2	21.7	20.5	21.5	20.7	19.9	19.6	19.0	17.8	17.1	16.7
38		21.3	21.7	20.7	21.5	21.5	19.8	20.8	20.4	19.3	19.6	18.8	17.8	17.1	16.8
40		19.9	21.1		20.7	20.2		20.1	19.2	19.0	19.5	17.8	17.8	17.1	16.9
42			19.9			19.0			19.5	18.0		18.6	16.8		17.1
44						17.9				17.0		17.5	15.8		16.9
46										16.0			14.9		14.1
48													14.1		13.3
50															12.6

メインブーム長さ ジブ長さ 作業半径(m)	40.3m+3.5m 36m			45.3m+3.5m 36m			50.4m+3.5m 36m			55.5m+3.5m 36m			60.5m+3.5m 36m		
	角度			角度			角度			角度			角度		
	82°	75°	68°	82°	75°	68°	82°	75°	68°	82°	75°	68°	82°	75°	68°
20	14.4														
22	14.3			10.5			8.1								
24	14.3			10.4			8.0			5.2			2.7		
26	14.2			10.4			8.0			5.1			2.6		
28	14.2			10.3			8.0			5.1			2.5		
30	14.2	13.7		10.3			7.9			5.0			2.5		
32	14.2	13.6		10.3	10.0		7.9			5.0			2.5		
34	14.2	13.5		10.3	10.0		7.9	7.4		4.9			2.4		
36	14.2	13.2		10.3	10.1		7.9	7.3		4.9	4.4		2.4		
38	14.2	13.0		10.3	10.0		7.9	7.3		4.9	4.3		2.4	1.9	
40	14.2	12.6	11.3	10.3	9.8		7.9	7.2		4.9	4.3		2.4	1.9	
42		12.3	10.8	10.3	9.6	8.5	7.9	7.0		4.9	4.3		2.4	1.9	
44		12.0	10.3		9.4	8.2		6.9			4.3		2.4	1.8	
46		11.8	9.9		9.2	7.8		6.7	5.5		4.3			1.8	
48			9.5		9.1	7.5		6.5	5.2		4.3	3.4		1.8	
50			9.1			7.2			5.0		4.3	3.2		1.8	
52						7.0			4.7			3.0		1.8	1.6
54									4.5			2.9			1.6
56												2.7			1.6
58															1.4

54505

# 起伏式ジブ定格総荷重表 TN

# LTM 1400NX



14.9m—55.5m



82°/75°/68°  
42m

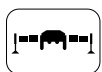

8.9m × 8.53m



360°



100t

メイン長さ ジブ長さ (m)	14.9m+3.5m			20.0m+3.5m			25.0m+3.5m			30.1m+3.5m			35.2m+3.5m			40.3m+3.5m			45.3m+3.5m			50.4m+3.5m			55.5m+3.5m		
	82°	75°	68°	82°	75°	68°	82°	75°	68°	82°	75°	68°	82°	75°	68°	82°	75°	68°	82°	75°	68°	82°	75°	68°	82°	75°	68°
18	22.1			20.9																							
20	22.1			20.7			19.0			16.6			14.7														
22	21.7			20.5			18.9			16.5			14.5			11.8			8.5								
24	21.3	21.2		20.4			18.7			16.4			14.4			11.7			8.5			6.3					
26	20.9	20.7		20.3	20.0		18.5			16.3			14.4			11.6			8.4			6.2			3.5		
28	20.4	20.2		19.9	19.7		18.5	18.1		16.3	15.9		14.3			11.6			8.4			6.1			3.5		
30	19.8	19.8		19.6	19.3		18.5	18.1		16.3	15.8		14.3	13.9		11.6			8.3			6.0			3.4		
32	18.9	19.2	19.2	18.8	19.0		18.3	18.0		16.2	15.7		14.3	13.9		11.6	11.1		8.3			5.9			3.4		
34	18.0	18.7	18.7	18.0	18.6	18.5	17.7	17.8		16.2	15.7		14.3	13.8		11.6	11.1		8.3	8.0		5.9			3.3		
36	17.1	17.9	18.3	17.2	18.1	18.2	17.0	17.6	17.4	16.2	15.7		14.3	13.8		11.6	11.1		8.3	8.0		5.8	5.4		3.3		
38	16.3	17.0	17.7	16.4	17.3	17.8	16.3	17.3	17.1	15.8	15.7	15.4	14.3	13.8		11.6	11.0		8.3	8.0		5.8	5.3		3.2	2.8	
40	15.6	16.3	16.9	15.6	16.5	17.3	15.6	16.6	16.9	15.3	15.7	15.4	14.3	13.8	13.4	11.6	10.9		8.3	8.0		5.7	5.3		3.2	2.8	
42	14.9	15.5	16.2	15.0	15.8	16.6	15.0	15.9	16.6	14.8	15.6	15.3	14.3	13.8	13.4	11.6	10.8	9.9	8.3	8.0		5.7	5.2		3.2	2.7	
44		14.9	15.4	14.5	15.1	15.9	14.5	15.3	16.2	14.3	15.1	15.2	13.9	13.8	13.4	11.6	10.6	9.5	8.3	8.0		5.7	5.2		3.2	2.7	
46		14.4	14.8	14.6	15.2		14.7	15.5		14.6	14.6	13.6	13.8	13.4	11.6	10.4	9.1	8.3	8.0	7.1		5.7	5.2		3.2	2.7	
48			14.3		14.6		14.2	14.9		14.2	13.8		13.8	13.0		10.1	8.8	8.3	7.9	6.8		5.7	5.2	4.6	3.2	2.7	
50					14.2			14.1		13.8	13.1		13.6	12.3		9.9	8.4		7.7	6.6		5.2	4.4		2.7		
52								13.4			12.4			11.7		9.8	8.1		7.6	6.3		5.2	4.2		2.7	2.5	
54											11.8			11.1			7.8	7.6		6.1		5.2	4.0		2.7	2.5	
56																	7.6			5.9			3.8		2.7	2.3	
58																				5.7			3.6		2.2		
60																							3.5		2.1		
62																									2.0		

54605

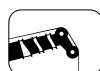

14.9m—55.5m



82°/75°/68°  
48m

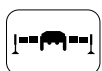

8.9m × 8.53m



360°







100t

メイン長さ ジブ長さ (m)	14.9m+3.5m			20.0m+3.5m			25.0m+3.5m			30.1m+3.5m			35.2m+3.5m			40.3m+3.5m			45.3m+3.5m			50.4m+3.5m			55.5m+3.5m			
	82°	75°	68°	82°	75°	68°	82°	75°	68°	82°	75°	68°	82°	75°	68°	82°	75°	68°	82°	75°	68°	82°	75°	68°	82°	75°	68°	
20	17.8			16.8			15.5																					
22	17.5			16.6			15.3			13.5			11.9															
24	17.5			16.5			15.2			13.3			11.8			9.6			6.9									
26	17.3			16.3			15.1			13.2			11.7			9.6			6.8			4.7			2.4			
28	17.1	17.0		16.2	15.9		15.0			13.2			11.6			9.6			6.7			4.6			2.3			
30	16.9	16.6		16.1	15.8		14.9	14.6		13.1			11.6			9.5			6.7			4.6			2.3			
32	16.6	16.3		16.1	15.8		14.9	14.5		13.1	12.8		11.6			9.5			6.7			4.5			2.2			
34	16.4	16.0	15.8	16.0	15.7		14.9	14.4		13.1	12.7		11.6	11.2		9.5			6.7			4.4			2.2			
36	16.3	15.8	15.6	15.9	15.5	15.2	14.8	14.4		13.1	12.7		11.6	11.2		9.5	9.1		6.6			4.4			2.1			
38	16.2	15.6	15.3	15.8	15.3	15.0	14.8	14.4	14.1	13.1	12.6		11.6	11.2		9.5	9.1		6.6	6.3		4.3			2.1			
40	16.2	15.4	15.0	15.8	15.1	14.8	14.8	14.3	14.1	13.1	12.6	12.3	11.6	11.2		9.5	9.1		6.6	6.3		4.3	3.9		2.1			
42	16.2	15.3	14.8	15.8	15.0	14.6	14.8	14.3	13.9	13.1	12.6	12.3	11.6	11.2		9.5	9.0		6.6	6.2		4.2	3.8		2.1	1.6		
44	16.2	15.3	14.7	15.8	14.9	14.4	14.8	14.2	13.8	13.1	12.6	12.3	11.6	11.1	10.8	9.5	9.0		6.6	6.2		4.2	3.8		2.1	1.6		
46	15.9	15.3	14.5	15.8	14.9	14.3	14.8	14.2	13.7	13.1	12.6	12.3	11.6	11.1	10.8	9.5	8.9	8.3	6.6	6.2		4.2	3.8		2.1	1.6		
48	14.7	15.3	14.5	15.8	14.9	14.2	14.8	14.2	13.6	13.1	12.6	12.3	11.6	11.1	10.8	9.5	8.8	8.0	6.6	6.2	5.9	4.2	3.8		2.1	1.6		
50		15.3	14.5	14.2	14.9	14.2	14.8	14.2	13.5	13.1	12.6	12.3	11.6	11.1	10.8	9.5	8.7	7.7	6.6	6.2	5.8	4.2	3.8		2.1	1.6		
52		13.3	14.5		14.9	14.0		14.2	13.2		12.6	12.1	11.6	11.1	10.8	9.5	8.6	7.4	6.6	6.2	5.6	4.2	3.8	3.6	2.1	1.6		
54			14.0		13.3		13.7	12.5		12.6	11.5		11.1	10.8		8.4	7.2		6.2	5.4	4.2	3.8	3.5	2.1	1.6			
56					12.6			11.9		12.3	10.9		11.1	10.4		8.3	6.9		6.2	5.2		3.8	3.3		1.6	1.5		
58								11.3			10.4			9.8		8.2	6.7		6.2	5.1		3.8	3.1		1.6	1.6		
60										9.9				9.4			6.4		6.2	4.9		3.8	3.0		1.6	1.6		
62																	6.2			4.7			2.9		1.6	1.6		
64																				4.5			2.7		1.5			
66																						2.6			1.4			
68																										1.2		

54705

# 起伏式ジブ定格総荷重表 TN

# LTM 1400NX

 14.9m—50.4m
  82°/75°/68°  
54m
  8.9m×8.53m
  360°
  100t

メイン長さ ジブ長さ (m)	14.9m+3.5m			20.0m+3.5m			25.0m+3.5m			30.1m+3.5m			35.2m+3.5m			40.3m+3.5m			45.3m+3.5m			50.4m+3.5m		
	54m			54m			54m			54m			54m			54m			54m			54m		
角度	82°	75°	68°	82°	75°	68°	82°	75°	68°	82°	75°	68°	82°	75°	68°	82°	75°	68°	82°	75°	68°	82°	75°	68°
22	14.4			13.6			12.2																	
24	14.2			13.4			12.2			10.9			9.7											
26	14.0			13.3			12.2			10.8			9.6			7.8					5.3			
28	13.9			13.2			12.1			10.7			9.5			7.8					5.2		3.1	
30	13.8	13.6		13.0			12.1			10.6			9.4			7.7					5.1		3.0	
32	13.7	13.6		12.9	12.7		12.0	11.8		10.6			9.4			7.7					5.1		2.9	
34	13.6	13.4		12.9	12.6		11.9	11.7		10.6	10.3		9.3			7.6					5.0		2.9	
36	13.4	13.2		12.9	12.6		11.8	11.6		10.5	10.3		9.3	9.0		7.6					4.9		2.8	
38	13.3	13.0	12.7	12.9	12.6		11.8	11.5		10.5	10.2		9.3	9.0		7.5	7.1				4.9		2.8	
40	13.2	12.8	12.6	12.8	12.5	12.3	11.8	11.5		10.5	10.2		9.3	9.0		7.4	7.1				4.8	4.5	2.7	
42	13.1	12.6	12.4	12.8	12.4	12.2	11.8	11.5	11.2	10.5	10.1		9.3	9.0		7.3	7.0				4.7	4.4	2.7	
44	13.1	12.5	12.2	12.7	12.2	12.0	11.8	11.5	11.3	10.5	10.1	9.9	9.3	9.0		7.3	7.0				4.7	4.4	2.7	
46	13.1	12.4	12.0	12.7	12.2	11.8	11.8	11.5	11.2	10.5	10.1	9.8	9.3	9.0	8.7	7.3	7.0				4.7	4.4	2.7	
48	13.1	12.3	11.8	12.7	12.1	11.7	11.8	11.5	11.1	10.5	10.1	9.8	9.3	9.0	8.7	7.3	7.0				4.7	4.4	2.7	
50	13.1	12.3	11.8	12.7	12.1	11.6	11.8	11.5	11.0	10.5	10.1	9.8	9.3	9.0	8.7	7.3	7.0	6.7			4.7	4.4	2.7	
52	13.1	12.3	11.7	12.7	12.1	11.5	11.8	11.5	11.0	10.5	10.1	9.8	9.3	9.0	8.6	7.3	7.0	6.6			4.7	4.4	2.7	
54	12.1	12.3	11.7	12.7	12.1	11.5	11.8	11.5	10.9	10.5	10.1	9.8	9.3	9.0	8.6	7.3	7.0	6.4			4.7	4.4	2.7	
56		12.3	11.7	11.6	12.1	11.5	11.7	11.5	10.9	10.5	10.1	9.8	9.3	9.0	8.6	7.3	7.0	6.1			4.7	4.4	2.7	
58		11.2	11.7	12.1	11.5		11.5	10.9		10.1	9.8	9.3	9.0	8.6	7.3	7.0	5.9	4.7			4.4	4.3	2.7	
60			11.7		11.2		11.5	10.5		10.1	9.6		9.0	8.6		6.9	5.7			4.4	4.1	2.7		
62					10.6			10.0		10.1	9.2		9.0	8.6		6.8	5.5			4.4	4.0	2.3		
64								9.5			8.7		8.1		6.8	5.3				4.4	3.8	2.3		
66											8.3			7.7			5.1			4.4	3.7	2.3		
68																	4.9				3.5	2.0		
70																					3.4	1.9		
72																						1.8		

54805

 14.9m—50.4m
  82°/75°/68°  
60m
  8.9m×8.53m
  360°
  100t

メイン長さ ジブ長さ (m)	14.9m+3.5m			20.0m+3.5m			25.0m+3.5m			30.1m+3.5m			35.2m+3.5m			40.3m+3.5m			45.3m+3.5m			50.4+3.5		
	60m			60m			60m			60m			60m			60m			60m			60m		
角度	82°	75°	68°	82°	75°	68°	82°	75°	68°	82°	75°	68°	82°	75°	68°	82°	75°	68°	82°	75°	68°	82°	75°	68°
24	11.4			10.8			10.1																	
26	11.3			10.7			9.9			8.8			7.7											
28	11.1			10.6			9.8			8.7			7.7			5.8					3.4			
30	11.0			10.5			9.7			8.6			7.6			5.7					3.3		1.5	
32	10.9	10.8		10.4			9.6			8.5			7.5			5.6					3.3		1.4	
34	10.8	10.7		10.3	10.2		9.6			8.5			7.5			5.5					3.2		1.4	
36	10.7	10.6		10.2	10.1		9.5	9.3		8.4	8.2		7.4			5.5					3.2		1.4	
38	10.7	10.6		10.2	10.0		9.4	9.3		8.4	8.2		7.4	7.2		5.4					3.1		1.3	
40	10.6	10.4	10.2	10.1	9.9		9.4	9.2		8.4	8.1		7.4	7.2		5.3	5.0				3.1		1.3	
42	10.5	10.3	10.1	10.0	9.8	9.7	9.3	9.1		8.3	8.1		7.4	7.1		5.3	4.9				3.0	2.7	1.3	
44	10.5	10.2	10.0	10.0	9.8	9.7	9.3	9.0		8.3	8.1		7.3	7.1		5.3	4.9				3.0	2.7	1.3	
46	10.4	10.1	9.9	10.0	9.8	9.7	9.3	9.0	8.9	8.3	8.0		7.3	7.1		5.2	4.9				3.0	2.7	1.3	
48	10.4	10.0	9.7	10.0	9.7	9.6	9.3	9.0	8.8	8.3	8.0	7.8	7.3	7.1		5.2	4.9				3.0	2.7	1.3	
50	10.4	9.9	9.6	10.0	9.7	9.4	9.3	9.0	8.8	8.3	8.0	7.8	7.3	7.1	6.9	5.2	4.9				3.0	2.7	1.3	
52	10.3	9.9	9.4	9.9	9.7	9.4	9.3	9.0	8.8	8.3	8.0	7.8	7.3	7.1	6.9	5.2	4.9	4.9			3.0	2.7	1.3	
54	10.3	9.9	9.4	9.9	9.6	9.3	9.3	9.0	8.8	8.3	8.0	7.7	7.3	7.1	6.8	5.2	4.9	4.9			3.0	2.7	1.3	
56	10.3	9.9	9.3	9.9	9.6	9.2	9.3	9.0	8.8	8.3	8.0	7.7	7.3	7.1	6.8	5.2	4.9	5.0			3.0	2.7	1.3	
58	10.3	9.9	9.3	9.9	9.6	9.2	9.3	9.0	8.8	8.3	8.0	7.7	7.3	7.1	6.8	5.2	4.9	5.0			3.0	2.7	1.3	
60	9.4	9.9	9.3	9.9	9.6	9.2	9.3	9.0	8.8	8.3	8.0	7.7	7.3	7.1	6.8	5.2	4.9	5.0			3.0	2.7	1.3	
62		9.9	9.3	9.2	9.6	9.2	9.3	9.0	8.8	8.3	8.0	7.7	7.3	7.1	6.8	5.2	4.9	4.8			3.0	2.7	1.3	
64		8.9	9.3		9.6	9.2		9.0	8.8		8.0	7.7	7.3	7.1	6.8	5.2	4.9	4.7			3.0	2.7	1.3	
66			9.3			9.2		9.0	8.8		8.0	7.7	7.3	7.1	6.8	5.2	4.9	4.5			2.7	3.0	1.3	
68						9.0			8.4		8.0	7.6	7.1	6.8		4.9	4.3				2.7	3.0	1.3	
70									8.0			7.3		6.7		4.9	4.1				2.7	2.8		
72												6.9				6.4					3.9	2.7		
74																					3.8	2.6		
76																						2.5		

54905

# 起伏式ジブ定格総荷重表 TN

# LTM 1400NX

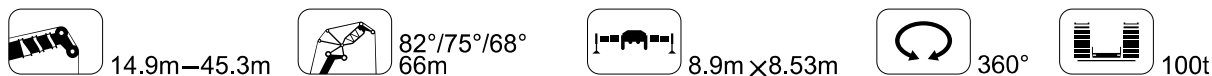

作業半径(m)	14.9m+3.5m			20.0m+3.5m			25.0m+3.5m			30.1m+3.5m			35.2m+3.5m			40.3m+3.5m			45.3m+3.5m				
	ジブ長さ 66m			66m			66m			66m			66m			66m			66m				
	角度	82°	75°	68°	82°	75°	68°	82°	75°	68°	82°	75°	68°	82°	75°	68°	82°	75°	68°	82°	75°	68°	
26	9.2			8.8			8.1																
28	9.1			8.6			8.0			7.1			6.1										
30	9.0			8.5			7.9			7.0			6.1				4.1				2.0		
32	8.9			8.4			7.8			6.9			6.0				4.0				1.9		
34	8.8	8.7		8.4			7.7			6.8			5.9				3.9				1.9		
36	8.7	8.6		8.3	8.2		7.7			6.8			5.8				3.8				1.8		
38	8.6	8.5		8.2	8.1		7.6	7.5		6.7			5.7				3.8				1.7		
40	8.6	8.4		8.1	8.0		7.6	7.4		6.6	6.5		5.6	5.4			3.7				1.7		
42	8.5	8.4		8.1	7.9		7.5	7.4		6.6	6.5		5.6	5.3			3.7	3.4			1.7		
44	8.5	8.3	8.1	8.0	7.8		7.5	7.3		6.6	6.4		5.6	5.3			3.7	3.3			1.6	1.4	
46	8.4	8.2	8.1	7.9	7.8	7.7	7.4	7.2		6.6	6.4		5.6	5.3			3.7	3.3			1.6	1.4	
48	8.4	8.2	8.0	7.9	7.8	7.6	7.4	7.2	7.1	6.6	6.4		5.6	5.3			3.7	3.3			1.6	1.4	
50	8.3	8.1	7.9	7.9	7.8	7.6	7.4	7.2	7.0	6.6	6.4	6.2	5.6	5.3			3.7	3.3			1.6	1.5	
52	8.3	8.0	7.8	7.9	7.8	7.6	7.3	7.1	7.0	6.6	6.3	6.2	5.6	5.3	5.3		3.7	3.3			1.6	1.5	
54	8.3	7.9	7.7	7.9	7.7	7.6	7.3	7.1	6.9	6.6	6.3	6.1	5.6	5.3	5.3	3.7	3.3				1.6	1.6	
56	8.2	7.9	7.7	7.9	7.7	7.5	7.3	7.1	6.9	6.6	6.3	6.1	5.6	5.3	5.3	3.7	3.3	3.4			1.6	1.6	
58	8.2	7.9	7.6	7.9	7.7	7.5	7.3	7.1	6.9	6.6	6.3	6.1	5.6	5.3	5.3	3.7	3.3	3.4	1.6	1.7	1.4		
60	8.2	7.9	7.5	7.9	7.7	7.4	7.3	7.1	6.9	6.6	6.3	6.1	5.6	5.3	5.3	3.7	3.3	3.4	1.6	1.7	1.5		
62	8.2	7.9	7.5	7.9	7.7	7.4	7.3	7.1	6.9	6.6	6.3	6.1	5.6	5.3	5.3	3.7	3.3	3.4	1.6	1.7	1.5		
64	8.2	7.9	7.5	7.9	7.7	7.4	7.3	7.1	6.9	6.6	6.3	6.1	5.6	5.3	5.3	3.7	3.3	3.4	1.6	1.7	1.6		
66	7.9	7.9	7.5	7.9	7.7	7.4	7.3	7.1	6.9	6.6	6.3	6.1	5.6	5.3	5.3	3.7	3.3	3.4	1.6	1.7	1.7		
68		7.9	7.5	7.7	7.7	7.4	7.3	7.1	6.9	6.6	6.3	6.1	5.6	5.3	5.3	3.7	3.3	3.4	1.6	1.7	1.7		
70			7.6	7.5	7.7	7.4	7.3	7.1	6.9	6.6	6.3	6.1	5.6	5.3	5.3	3.7	3.3	3.4	1.6	1.7	1.7		
72				7.5		7.4		7.1	6.9	6.6	6.3	6.1	5.6	5.3	5.3		3.3	3.4		1.7	1.7		
74						7.4		7.1	6.9	6.6	6.3	6.1	5.6	5.3	5.3		3.3	3.4		1.7	1.7		
76								7.1	6.9	6.6	6.3	6.1	5.6	5.3	5.3		3.3	3.3		1.7	1.7		
78									6.9	6.6	6.3	6.1	5.6	5.3	5.3		3.3	3.3		1.7	1.7		
80										6.7			6.0				5.3	3.1		1.7	1.7		
82																	5.2	3.0		1.7	1.7		

55005

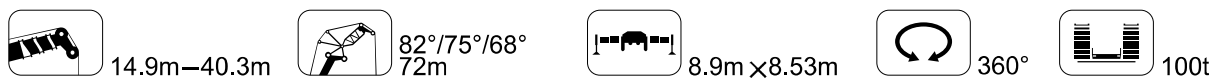

作業半径(m)	14.9m+3.5m			20.0m+3.5m			25.0m+3.5m			30.1m+3.5m			35.2m+3.5m			40.3m+3.5m							
	ジブ長さ 72m			72m			72m			72m			72m			72m							
	角度	82°	75°	68°	82°	75°	68°	82°	75°	68°	82°	75°	68°	82°	75°	68°	82°	75°	68°				
26	7.2																						
28	7.2			6.8			6.3																
30	7.2			6.8			6.3			5.5			4.6										
32	7.1			6.7			6.2			5.5			4.5								2.7		
34	7.0			6.6			6.1			5.4			4.4								2.7		
36	6.9			6.5			6.0			5.3			4.3								2.6		
38	6.8	6.6		6.5	6.2		6.0			5.3			4.2								2.5		
40	6.7	6.6		6.4	6.2		5.9	5.7		5.2			4.1								2.5		
42	6.6	6.6		6.3	6.2		5.8	5.8		5.2		5.0	4.0								2.4		
44	6.6	6.5		6.3	6.2		5.8	5.7		5.1	5.0		4.0								2.4		
46	6.5	6.4		6.2	6.1		5.8	5.7		5.1	4.9		4.0	3.8							2.4	2.2	
48	6.4	6.4	6.1	6.1	6.0		5.7	5.6		5.1	4.9		4.0	3.9							2.4	2.2	
50	6.4	6.3	6.2	6.1	6.0	5.8	5.7	5.6		5.0	4.9		4.0	3.9							2.4	2.3	
52	6.4	6.3	6.2	6.1	5.9	5.8	5.7	5.5	5.3	5.0	4.9		4.0	3.9							2.4	2.3	
54	6.4	6.2	6.1	6.0	5.9	5.8	5.6	5.5	5.4	5.0	4.8	4.7	4.0	3.9							2.4	2.3	
56	6.4	6.2	6.1	6.0	5.9	5.8	5.6	5.5	5.3	5.0	4.8	4.7	4.0	3.9							2.4	2.3	
58	6.4	6.1	6.0	6.0	5.9	5.8	5.6	5.4	5.3	5.0	4.8	4.7	4.0	3.9	3.9						2.4	2.4	
60	6.4	6.1	5.9	6.0	5.9	5.8	5.6	5.4	5.3	5.0	4.8	4.6	4.0	3.9	3.9						2.4	2.4	2.2
62	6.3	6.1	5.9	6.0	5.9	5.7	5.6	5.4	5.3	5.0	4.7	4.6	4.0	3.9	3.9						2.4	2.4	2.3
64	6.3	6.1	5.8	6.0	5.9	5.7	5.6	5.4	5.3	5.0	4.7	4.6	4.0	3.9	3.9						2.4	2.5	2.4
66	6.3	6.1	5.8	6.0	5.9	5.7	5.6	5.4	5.3	5.0	4.7	4.5	4.0	3.9	3.9						2.4	2.4	2.4
68	6.3	6.1	5.8	6.0	5.9	5.7	5.6	5.4	5.3	5.0	4.7	4.5	4.0	3.9	3.9						2.4	2.4	2.5
70	6.3	6.1	5.8	6.0	5.9	5.7	5.6	5.4	5.3	5.0	4.7	4.5	4.0	3.9	3.9						2.4	2.4	2.4
72	6.3	6.1	5.8	6.0	5.9	5.7	5.6	5.4	5.3	5.0	4.7	4.5	4.0	3.9	3.9						2.4	2.4	2.4
74		6.1	5.8	5.8	5.9	5.7	5.6	5.4	5.3	5.0	4.7	4.5	4.0	3.9	3.9						2.4	2.4	2.4
76			6.1	5.8		5.9	5.7	5.4	5.3		4.7	4.5	4.0	3.9	3.9						2.4	2.4	2.4
78				5.8		5.9	5.7	5.4	5.3		4.7	4.5	4.0	3.9	3.9						2.4	2.4	2.4
80						5.7		5.4	5.3		4.7	4.5	4.0	3.9	3.9						2.4	2.4	2.4
82							5.7		5.3		4.7	4.5	4.0	3.9	3.9						2.4	2.4	2.4
84									5.3			4.5			3.9						2.4	2.3	
86												4.5			3.9						2.4	2.2	

55105

# 起伏式ジブ定格総荷重表 TN

# LTM 1400NX



14.9m—35.2m

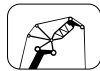

82°/75°/68°  
78m

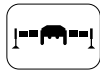

8.9m×8.53m



360°



100t

メインブーム長さ ジブ長さ 作業半径(m)	14.9m+3.5m 78m			20.0m+3.5m 78m			25.0m+3.5m 78m			30.1m+3.5m 78m			35.2m+3.5m 78m		
	82°	75°	68°	82°	75°	68°	82°	75°	68°	82°	75°	68°	82°	75°	68°
28	5.7														
30	5.7						4.9								
32	5.6			5.3			4.9			4.0			3.0		
34	5.6			5.3			4.8			3.9			2.9		
36	5.5			5.2			4.8			3.9			2.8		
38	5.4			5.1			4.7			3.8			2.7		
40	5.3	5.1		5.0			4.6			3.7			2.7		
42	5.2	5.1		5.0	4.8		4.6	4.3		3.6			2.6		
44	5.2	5.1		4.9	4.8		4.5	4.3		3.6	3.4		2.6		
46	5.1	5.0		4.8	4.8		4.5	4.3		3.6	3.5		2.6	2.4	
48	5.0	5.0		4.8	4.7		4.4	4.3		3.6	3.5		2.6	2.5	
50	5.0	4.9	4.5	4.7	4.7		4.4	4.3		3.6	3.5		2.6	2.5	
52	4.9	4.8	4.6	4.7	4.6	4.2	4.3	4.2		3.6	3.6		2.6	2.5	
54	4.9	4.8	4.7	4.7	4.6	4.3	4.3	4.2	3.8	3.6	3.6		2.6	2.6	
56	4.9	4.8	4.7	4.6	4.5	4.4	4.3	4.2	3.9	3.6	3.5	3.3	2.6	2.6	
58	4.8	4.8	4.7	4.6	4.5	4.4	4.3	4.1	3.9	3.6	3.5	3.4	2.6	2.6	
60	4.8	4.7	4.7	4.6	4.4	4.3	4.3	4.1	3.9	3.6	3.5	3.4	2.6	2.6	2.5
62	4.8	4.7	4.6	4.6	4.4	4.3	4.2	4.0	3.9	3.6	3.5	3.4	2.6	2.7	2.6
64	4.8	4.7	4.5	4.6	4.4	4.3	4.2	4.0	3.9	3.6	3.5	3.4	2.6	2.7	2.6
66	4.8	4.6	4.4	4.6	4.4	4.3	4.2	4.0	3.9	3.6	3.5	3.4	2.6	2.7	2.7
68	4.8	4.6	4.4	4.6	4.4	4.3	4.2	4.0	3.9	3.6	3.5	3.4	2.6	2.7	2.6
70	4.7	4.6	4.4	4.5	4.4	4.3	4.2	4.0	3.9	3.6	3.5	3.4	2.6	2.6	2.6
72	4.7	4.6	4.4	4.5	4.4	4.3	4.2	4.0	3.9	3.6	3.5	3.3	2.6	2.6	2.6
74	4.7	4.6	4.4	4.5	4.4	4.3	4.2	4.0	3.9	3.6	3.5	3.3	2.6	2.6	2.6
76	4.7	4.6	4.4	4.5	4.4	4.3	4.2	4.0	3.9	3.6	3.5	3.3	2.6	2.6	2.6
78	4.7	4.6	4.4	4.5	4.4	4.3	4.2	4.0	3.9	3.6	3.5	3.3	2.6	2.6	2.6
80		4.6	4.4		4.4	4.3	4.2	4.0	3.9	3.6	3.5	3.3	2.6	2.6	2.6
82		4.6	4.4		4.4	4.3		4.0	3.9		3.5	3.3	2.6	2.6	2.6
84			4.4			4.3		4.0	3.9		3.5	3.3		2.6	2.6
86						4.3			3.9		3.5	3.3		2.6	2.6
88									3.9			3.3			2.6
90															2.6

55205

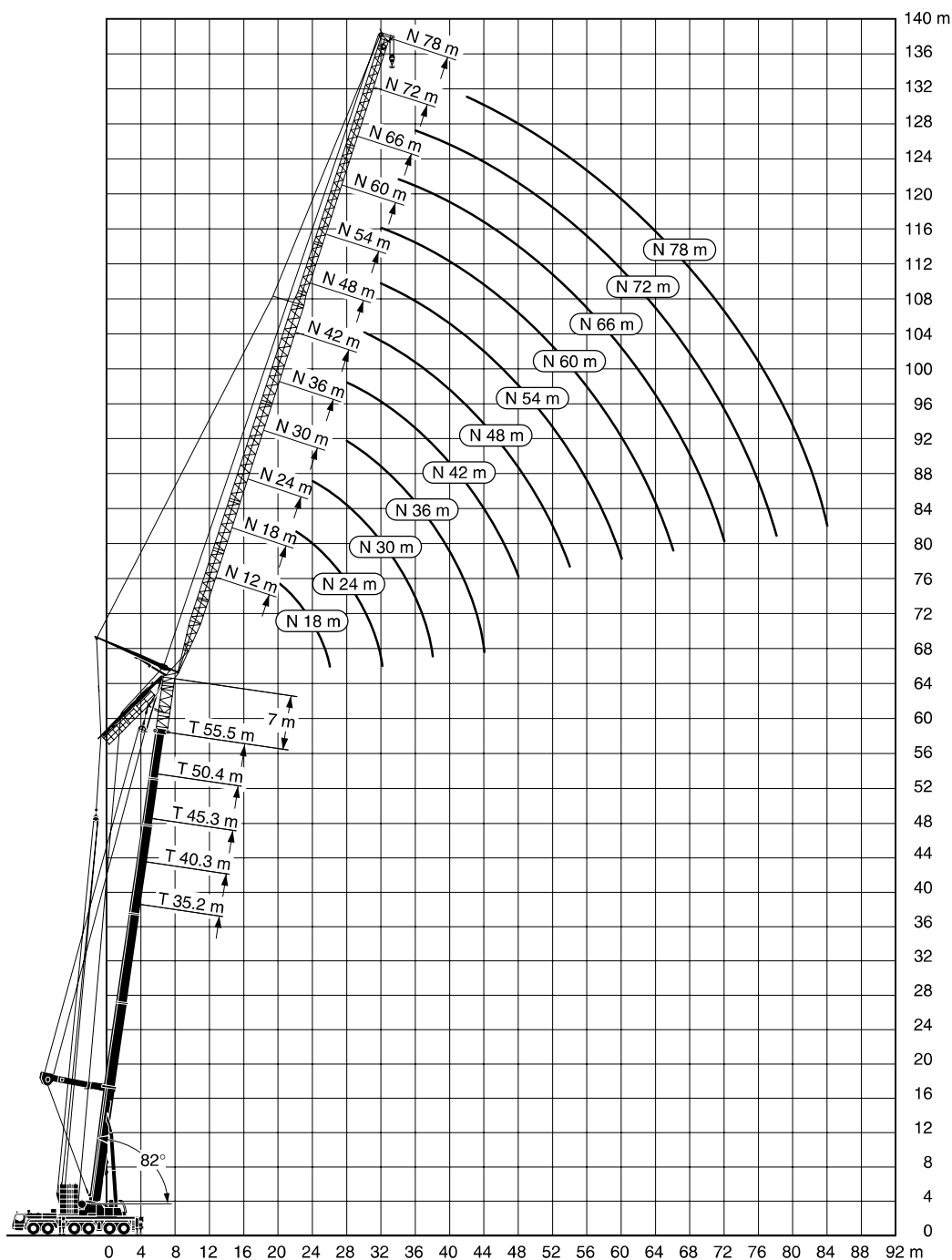

**注意**

- 1 定格総荷重はフックブロック、玉掛ワイヤー等の自重を含みます。  
また、下記の条件が考慮されていないのでクレーンの操作には充分気をつけてください。
  - ① 地盤の強度、地震による影響
  - ② 作業速度に応じた動荷重および台風または強風による影響等
- 2 本機は水平に設置して、クレーン作業を行ってください。
- 3 作業半径は、クレーンの旋回中心から荷重の重心までの水平距離です。
- 4 メインブームの定格総荷重は補助ジブを取り除いた状態での値です。
- 5 メインブーム70m仕様で200トンを超える定格総荷重の場合は、特殊吊装置が必要です。



# 起伏式ジブ (ガイ、エクステンダー仕様) 定格総荷重表 TYVEN

# LTM 1400NX

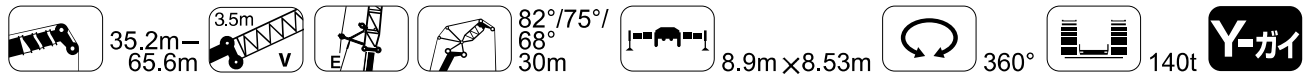

メインブーム長さ ジブ長さ	35.2m+7m 30m			40.3m+7m 30m			45.3m+7m 30m			50.4m+7m 30m			55.5m+7m 30m			60.5m+7m 30m			65.6m+7m 30m				
	82°	75°	68°	82°	75°	68°	82°	75°	68°	82°	75°	68°	82°	75°	68°	82°	75°	68°	82°	75°	68°		
18	26.5																						
20	27.8			27.5																			
22	29.4			28.3			25.5			23.3													
24	30.4			28.2			25.5			23.0			20.2			17.8							
26	30.2			27.7			25.2			22.7			20.0			17.5				15.4			
28	29.6	29.5		27.0			24.8			22.3			19.6			17.2				15.1			
30	28.0	28.2		25.5	25.2		24.4			21.9			19.3			16.8				14.8			
32	26.4	26.8		24.2	23.9		23.8	23.5		21.5			18.9			16.5				14.5			
34	24.9	25.5		22.8	22.8		22.6	22.4		21.1	20.7		18.5			16.2				14.2			
36		24.3	22.4	21.5	21.7		21.5	21.3		20.2	19.7		18.2	17.6		15.8	15.3			13.8			
38		23.1	21.1		20.6	19.4		20.4		18.8	18.8		17.9	17.3		15.5	15.0			13.4		12.7	
40		21.9	19.9		19.7	18.3		19.5	17.4	18.0	18.0			16.8		14.6	14.6			12.1		12.1	
42			18.8			17.3		18.6	16.5	17.2	17.2			16.1		14.0	14.0			11.5		11.5	
44			17.8			16.4			15.6	16.4	16.4	14.2		15.4		13.4	13.4			11.0		11.0	
46						15.6			14.8			13.5			12.3		12.7	12.7			10.5		10.5
48									14.1			12.8			11.6				6.4		10.0		10.0
50												12.1			11.0				6.4				4.8
52															10.5				6.3				4.9
54																			6.0				4.9
56																							4.8

64401

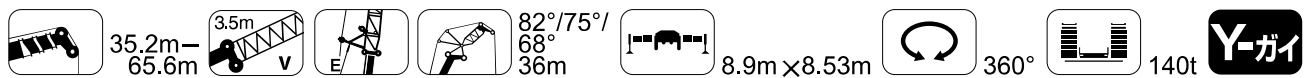

メインブーム長さ ジブ長さ	35.2m+7m 36m			40.3m+7m 36m			45.3m+7m 36m			50.4m+7m 36m			55.5m+7m 36m			60.5m+7m 36m			65.6m+7m 36m			
	82°	75°	68°	82°	75°	68°	82°	75°	68°	82°	75°	68°	82°	75°	68°	82°	75°	68°	82°	75°	68°	
20	22.2																					
22	23.1			22.5			17.1															
24	24.1			23.0			19.4			18.6												
26	24.8			23.2			21.0			19.2			16.8			14.7						
28	24.5			23.1			21.1			19.1			16.8			14.7				12.8		
30	24.1	23.6		22.8			20.9			18.8			16.6			14.5				12.7		
32	23.2	23.6		22.3	21.7		20.6			18.6			16.3			14.2				12.5		
34	22.2	23.0		21.2	20.7		20.3	19.9		18.3			16.1			13.9				12.2		
36	21.2	22.0		20.2	19.7		20.0	19.7		18.0	17.5		15.8			13.7				12.0		
38	20.3	21.0	20.5	19.2	18.9		19.7	19.3		17.7	17.3		15.5	15.0		13.4	12.9			11.7		
40	19.4	20.1	19.7	18.2	18.0	17.2	18.9	18.5		17.4	17.0		15.2	14.8		13.1	12.7			11.4		
42		19.3	18.7		17.2	16.6	18.0	17.7		16.9	16.3		15.0	14.6		12.9	12.5			11.2	10.5	
44		18.4	17.7		16.5	15.9		17.0	15.2		15.6		14.7	14.3		12.6	12.3			10.9	10.1	
46		17.5	16.8		15.8	15.3		16.3	14.4		15.0	13.0		13.9		12.0	12.0			9.7	9.7	
48			16.0			14.6		15.7	13.7		14.4	12.3		13.4		11.3	11.3			9.3	9.3	
50			15.2			13.9			13.0		13.8	11.7		12.8		10.5	10.4			8.9	8.9	
52						13.2			12.4			11.1			10.0		9.4			8.5	8.5	
54									11.8			10.5			9.5		8.6			8.2	8.2	4.2
56												10.0			9.1					4.3	4.3	
58															8.6					4.2	4.2	
60																				4.1	4.1	
62																				3.9	3.9	

64501

# 起伏式ジブ(ガイ、エクステンダー仕様) 定格総荷重表 TYVEN

# LTM 1400NX



メインブーム長さ ジブ長さ	35.2m+7m 42m			40.3m+7m 42m			45.3m+7m 42m			50.4m+7m 42m			55.5m+7m 42m			60.5m+7m 42m			65.6m+7m 42m				
	角度	82°	75°	68°	82°	75°	68°	82°	75°	68°	82°	75°	68°	82°	75°	68°	82°	75°	68°	82°	75°	68°	
作業半径(m)																							
22	20.0			18.0																			
24	20.4			18.5			16.2																
26	20.5			18.9			17.0																
28	20.3			19.0			17.3				14.2												
30	19.8			19.0			17.3				15.5			11.0			12.0						
32	19.2	19.2		18.4			17.3				15.8			13.5			12.0					10.6	
34	18.5	19.2		18.4	18.3		17.1				15.7			13.8			12.0					10.6	
36	17.6	18.5		17.9	18.0		16.9	16.5			15.5			13.7			11.9					10.5	
38	16.7	17.7		17.0	17.2		16.6	16.4			15.3			13.5			11.7					10.3	
40	16.0	16.9		16.3	16.4		16.4	16.2			15.1	14.6		13.3			11.5					10.1	
42	15.2	16.1	15.5	15.5	15.7		15.8	16.0			14.9	14.5		13.1			11.3					9.9	
44	14.5	15.4	14.9	14.8	15.0	14.0	15.8	16.0			14.6	14.3		12.9	12.4		11.1	10.6				9.7	
46	13.9	14.8	14.3	14.2	14.3	13.5	14.4	14.8	13.9		14.4	14.2		12.7	12.3		10.9	10.5				9.5	9.0
48		14.1	13.8		13.7	13.0	13.9	14.1	13.4		14.2	13.9		12.5	12.1		10.7	10.3				9.3	8.9
50		13.4	13.2		13.1	12.5	13.4	14.1	13.4		14.0	13.4		12.3	11.9		10.5	10.1				9.1	8.6
52		12.6	12.7		12.5	12.0	13.1	12.2			12.9	11.4		11.7	11.7		10.3	10.0				8.9	8.2
54			12.2			11.6	12.6	11.6			12.4	10.8		11.5	11.5		9.8	9.8				8.7	7.9
56			11.7			11.1		11.1			11.9	10.3		11.2	9.1		9.5	3.3				8.6	7.6
58						10.7		10.6			11.5	9.8		10.8	8.6		8.7	3.3				8.2	7.3
60								10.1				9.3			7.8		7.8	3.3				8.2	7.0
62												8.9			7.8		7.4	3.2				7.8	6.7
64												8.5			7.4		7.1	3.2				7.4	6.7
66															7.1			3.1				7.1	6.7
68																		2.8				7.1	6.7

64601



メインブーム長さ ジブ長さ	35.2m+7m 48m			40.3m+7m 48m			45.3m+7m 48m			50.4m+7m 48m			55.5m+7m 48m			60.5m+7m 48m			65.6m+7m 48m				
	角度	82°	75°	68°	82°	75°	68°	82°	75°	68°	82°	75°	68°	82°	75°	68°	82°	75°	68°	82°	75°	68°	
作業半径(m)																							
24	16.1			14.3																			
26	16.5			14.8			13.7																
28	16.6			15.3			14.1																
30	16.6			15.5			14.3				12.0			10.9									
32	16.4			15.6			14.3				12.7			11.2			10.0						
34	16.2	15.6		15.7			14.3				13.0			11.4			10.1					8.9	
36	16.0	15.6		15.6	15.0		14.2				13.1			11.4			10.1					8.9	
38	15.9	15.5		15.5	15.0		14.2	13.9			13.0			11.4			10.0					8.8	
40	15.7	15.5		15.4	15.0		14.1	13.8			12.9			11.3			10.0					8.8	
42	15.6	15.4		15.3	14.9		13.9	13.7			12.7	12.3		11.1			9.8					8.6	
44	15.1	14.7	13.9	15.0	14.3		13.7	13.5			12.6	12.2		11.0	10.5		9.7					8.5	
46	14.4	14.1	13.4	14.3	13.7		13.6	13.4			12.4	12.0		10.6	10.3		9.5	9.0				8.3	
48	13.7	13.5	12.9	13.7	13.1	12.1	13.4	13.0			12.2	11.8		10.8	10.4		9.3	8.9				8.1	7.6
50	13.0	13.0	12.5	13.0	12.5	11.7	13.1	12.4			12.1	11.7		10.5	10.2		9.2	8.8				8.0	7.5
52	12.3	12.4	12.0	12.4	12.0	11.2	12.5	11.9	11.5		11.9	11.7		10.3	10.0		9.0	8.7				7.8	7.4
54		11.9	11.5		11.5	10.8	11.8	11.5	10.7	11.1	11.8	11.5	10.5	10.2	9.9		8.9	8.5				7.6	7.2
56		11.3	11.1		11.0	10.4	11.0	10.3			11.1	10.0	10.1	9.8	9.8		8.7	8.4				7.5	7.0
58		10.6	10.7		10.5	10.0	11.0	9.9	10.3		10.6	9.5		9.7	8.8		8.6	8.3				7.3	6.7
60			10.3			9.7	10.5	9.9	10.1		10.3	9.0		9.5	8.4		8.2	7.9				7.3	6.7
62			9.9			9.3		10.1			9.5	8.6		9.1	8.0		7.9	7.9				7.3	6.7
64						8.9					9.2	8.6		8.8	7.6		7.4	7.4				7.3	6.7
66											8.8	7.8			7.3		6.6	6.6				7.3	6.7
68											8.5	7.5			6.9			6.6				7.3	6.7
70												7.1			6.6			6.6				7.3	6.7
72															6.3			6.6				7.3	6.7
74																		6.3				7.3	6.7

64701

# 起伏式ジブ (ガイ、エクステンター仕様) 定格総荷重表 TYVEN

# LTM 1400NX

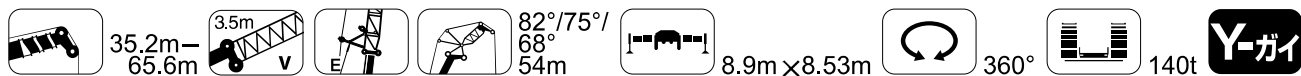

メインブーム長さ ジブ長さ	35.2m+7m 54m			40.3m+7m 54m			45.3m+7m 54m			50.4m+7m 54m			55.5m+7m 54m			60.5m+7m 54m			65.6m+7m 54m					
	角度	82°	75°	68°	82°	75°	68°	82°	75°	68°	82°	75°	68°	82°	75°	68°	82°	75°	68°	82°	75°	68°		
作業半径(m)																								
26	12.8			12.2																				
28	13.0			12.4				10.7																
30	13.3			12.5				11.1					10.0			7.1								
32	13.4			12.6				11.4					10.3			8.6			7.7					
34	13.3			12.6				11.5					10.4			8.9			7.9			7.0		
36	13.2	12.7		12.6				11.6					10.5			9.1			8.0			7.0		
38	13.1	12.6		12.6	12.2			11.5					10.5			9.1			8.0			7.0		
40	13.0	12.6		12.5	12.2			11.5	11.4				10.4			9.1			8.0			7.0		
42	12.8	12.5		12.5	12.2			11.4	11.3				10.4	10.1		9.1			7.9			6.9		
44	12.7	12.5		12.4	12.1			11.4	11.2				10.3	10.0		9.0			7.9			6.9		
46	12.6	12.5		12.3	11.7			11.3	11.1				10.2	9.9		8.9	8.5		7.8	7.3		6.7		
48	12.6	12.4	11.5	12.0	11.3			11.2	11.0				10.1	9.8	8.8	8.4		7.7	7.2			6.6		
50	12.5	12.2	11.5	11.5	10.8	9.8		11.1	10.9				9.9	9.7		8.7	8.3		7.5	7.1		6.5	6.0	
52	12.0	11.7	11.1	11.0	10.4	9.4	11.0	10.8	10.1				9.8	9.6		8.5	8.2		7.4	7.0		6.3	5.9	
54	11.5	11.2	10.7	10.5	9.9	9.1	10.9	10.7	9.7				9.7	9.5		8.4	8.1		7.3	6.9		6.2	5.8	
56	10.9	10.8	10.3	10.0	9.5	8.8	10.8	10.3	9.4	9.6	8.5		9.4	9.6	8.5	8.3	8.0		7.1	6.8		6.1	5.7	
58	10.4	10.4	9.9	9.5	9.1	8.4	10.4	9.9	9.0	9.5	9.3	8.2	8.2	7.9	7.3	7.0	6.7		6.9	6.6	1.8	5.9	5.6	
60		9.9	9.6		8.8	8.1		9.9	9.5	8.7	8.4		8.9	8.0	8.1	7.8	7.1		6.9	6.6		5.8	5.4	
62		9.5	9.2		8.4	7.8			9.1	8.4			8.6	7.7		7.7	7.0		6.8	6.5	1.9	5.7	5.3	
64		8.8	8.9		8.0	7.5			8.8	8.1			8.2	7.4		7.7	6.8			6.4	2.0		5.1	2.1
66			8.5			7.2			8.4	7.8			7.9	7.1		7.5	6.5			6.3	2.0		4.9	2.2
68			8.2			6.9				7.6			7.6	6.8		7.2	6.1			6.2	2.0		4.7	2.2
70						6.6				7.3				6.6			5.9			5.4	2.0		4.5	2.2
72										7.0							5.6				2.0		4.3	2.2
74														6.0							1.9			2.1
76																						1.7		2.1
78																						1.5		2.0
80																								1.8

64801

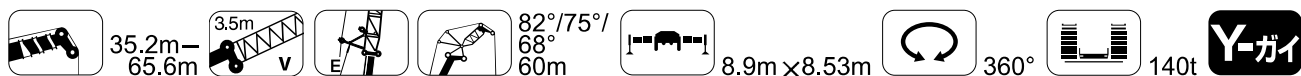

メインブーム長さ ジブ長さ	35.2m+7m 60m			40.3m+7m 60m			45.3m+7m 60m			50.4m+7m 60m			55.5m+7m 60m			60.5m+7m 60m			65.6m+7m 60m					
	角度	82°	75°	68°	82°	75°	68°	82°	75°	68°	82°	75°	68°	82°	75°	68°	82°	75°	68°	82°	75°	68°		
作業半径(m)																								
28	9.9			9.3																				
30	10.1			9.5				8.6					7.3											
32	10.2			9.7				8.8					7.8				6.3							
34	10.4			9.8				8.9					7.9						4.6					
36	10.5			9.9				9.0					8.0						5.6					
38	10.6			9.9				9.0					8.1						5.8				3.1	
40	10.5	10.1		9.9				9.0					8.1						6.0				5.2	
42	10.4	10.1		9.9	9.8			9.0	9.1				8.1						6.1				5.2	
44	10.3	10.0		9.9	9.8			9.0	9.0				8.1						6.0				5.2	
46	10.2	10.0		9.9	9.7			8.9	9.0				8.1	7.9					6.0				5.2	
48	10.1	9.9		9.8	9.7			8.9	8.9				8.0	7.9					6.0				5.1	
50	10.0	9.9		9.8	9.6			8.8	8.8				8.0	7.8					6.0				5.1	
52	9.9	9.8	9.2	9.8	9.6			8.8	8.7				8.0	7.8					5.9	5.6			5.0	
54	9.9	9.7	9.2	9.7	9.3	8.3		8.7	8.6				7.8	7.6					5.9	5.5			4.5	
56	9.8	9.7	9.2	9.6	8.9	8.0		8.7	8.6	8.1			7.7	7.5					5.8	5.4			4.9	
58	9.8	9.7	9.1	9.2	8.6	7.7	8.6	8.5	8.5	7.8			7.6	7.5	7.0				5.7	5.3			4.8	
60	9.6	9.3	8.8	8.8	8.2	7.4	8.4	8.4	8.4	7.5	7.6	7.4	6.9	6.4	6.2	1.8			5.6	5.2			4.7	
62	9.2	9.0	8.5	8.4	7.9	7.2	8.2	8.1	7.2	7.5	7.3	7.3	6.6	6.3	6.1	2.0			5.5	5.2			4.6	
64	8.7	8.6	8.2	8.0	7.6	6.9	7.9	7.7	7.0	7.3	7.2	6.4	6.3	6.0	5.8	2.2			5.4	5.1			4.5	
66		8.3	7.9		7.3	6.6	7.6	7.4	6.7	7.1	7.0	6.1	6.1	5.9	5.9	2.2			5.3	5.0			4.4	
68		7.9	7.6		6.9	6.4		7.1	6.5				6.7	5.9	5.9	2.3			5.2	4.9			4.3	
70		7.4	7.4		6.6	6.1		6.8	6.2				6.5	5.7	5.8	2.3			4.8	4.8	1.2		3.8	
72			7.1			5.9		6.5	6.0				6.2	5.4	5.8	2.3			4.7	4.7	1.2		3.7	
74			6.8			5.6			5.7				5.9	5.2	5.1	2.3			4.7	4.7	1.3		3.6	
76							5.4													4.4	4.4	1.2		3.5
78									5.5													1.2		3.3
80									5.3															3.3
82																								3.1
84																								1.2

64901

# 起伏式ジブ(ガイ、エクセンダー仕様) 定格総荷重表 TYVEN LTM 1400NX



メインブーム長さ ジブ長さ	35.2m+7m 66m			40.3m+7m 66m			45.3m+7m 66m			50.4m+7m 66m			55.5m+7m 66m			60.5m+7m 66m	
	角度			角度			角度			角度			角度			角度	
作業半径(m)	82°	75°	68°	82°	75°	68°	82°	75°	68°	82°	75°	68°	82°	75°	68°	82°	75°
28	8.3																
30	8.3																
32	8.4																
34	8.5																
36	8.5																
38	8.5																
40	8.5																
42	8.5																
44	8.4																
46	8.3																
48	8.2																
50	8.2																
52	8.1																
54	8.0																
56	8.0																
58	7.9																
60	7.9																
62	7.8																
64	7.6																
66	7.2																
68	6.8																
70	6.4																
72																	
74																	
76																	
78																	
80																	
82																	
84																	
86																	

65001



メインブーム長さ ジブ長さ	35.2m+7m 72m			40.3m+7m 72m			45.3m+7m 72m			50.4m+7m 72m			55.5m+7m 72m			60.5m+7m 72m	
	角度			角度			角度			角度			角度			角度	
作業半径(m)	82°	75°	68°	82°	75°	68°	82°	75°	68°	82°	75°	68°	82°	75°	68°	82°	75°
30	6.5																
32	6.5																
34	6.6																
36	6.6																
38	6.6																
40	6.7																
42	6.6																
44	6.6																
46	6.5																
48	6.5																
50	6.4																
52	6.4																
54	6.3																
56	6.3																
58	6.2																
60	6.1																
62	6.1																
64	6.0																
66	6.0																
68	5.9																
70	5.8																
72	5.7																
74	5.6																
76	5.3																
78																	
80																	
82																	
84																	
86																	
88																	
90																	
92																	

65101

# 起伏式ジブ (ガイ、エクセンダー仕様) 定格総荷重表 TYVEN

# LTM 1400NX

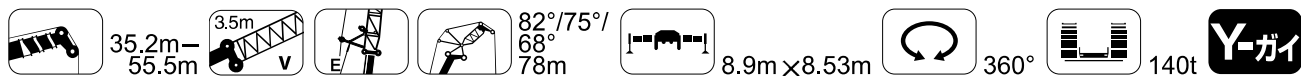

メインブーム長さ ジブ長さ 作業半径(m)	35.2m+7m 78m			40.3m+7m 78m			45.3m+7m 78m			50.4m+7m 78m			55.5m+7m 78m	
	82°	75°	68°	82°	75°	68°	82°	75°	68°	82°	75°	68°	82°	75°
32	4.8													
34	4.9													
36	4.9			4.5			3.6							
38	5.0			4.6			3.8			2.8				
40	4.9			4.6			3.9			3.0			1.3	
42	4.9			4.6			3.9			3.2			1.6	
44	4.8			4.6			4.0			3.3			1.8	
46	4.8			4.6			4.1			3.4			2.1	
46	4.8	4.5		4.6			4.1			3.4			2.4	
48	4.8	4.6		4.6	4.3		4.1			3.5			2.6	
50	4.7	4.6		4.5	4.4		4.1	4.0		3.5			2.6	
52	4.7	4.7		4.5	4.5		4.0	4.1		3.5	3.6		2.7	
54	4.7	4.7		4.4	4.5		4.0	4.2		3.5	3.6		2.7	2.9
56	4.6	4.8		4.4	4.6		3.9	4.2		3.5	3.6		2.7	2.8
58	4.6	4.8		4.4	4.6		3.9	4.2		3.5	3.5		2.7	2.8
60	4.5	4.8	3.9	4.3	4.6		3.8	4.1		3.4	3.5		2.7	2.7
62	4.5	4.7	4.0	4.2	4.6		3.7	4.1		3.4	3.4		2.7	2.7
64	4.4	4.7	4.1	4.2	4.6		3.7	4.0		3.3	3.4		2.7	2.6
66	4.4	4.6	4.2	4.1	4.5		3.6	4.0	3.4	3.2	3.3		2.7	2.6
68	4.3	4.6	4.2	4.0	4.5		3.5	4.0	3.5	3.2	3.3	2.5	2.6	2.6
70	4.3	4.5	4.3	4.0	4.4		3.4	3.9	3.6	3.1	3.3	2.6	2.5	2.5
72	4.2	4.5	4.3	3.9	4.3		3.3	3.9	3.6	3.0	3.2	2.7	2.4	2.5
74	4.1	4.5	4.3	3.8	4.1	3.4	3.2	3.9	3.6	2.9	3.2	2.8	2.3	2.5
76	4.1	4.4	4.2	3.8	3.9	3.3	3.1	3.8	3.5	2.7	3.2	2.8	2.2	2.4
78	4.0	4.4	4.0	3.7	3.7	3.1	3.0	3.8	3.4	2.6	3.1	2.8	2.1	2.4
80	4.0	4.2	3.8	3.6	3.5	3.0	2.8	3.8	3.2	2.5	3.1	2.7	2.0	2.3
82	3.9	4.0	3.7	3.5	3.4	2.9	2.7	3.7	3.1	2.3	3.1	2.7	1.8	2.3
84		3.8	3.5		3.1	2.1		3.5	2.9	2.2	3.0	2.6	1.6	2.3
86		3.5	3.3		2.9	1.4		3.3	2.8		3.0	2.5		2.3
88		3.2	3.2		2.7			3.2	2.7		3.0	2.3		2.2
90			3.0					2.9	2.6		2.8	2.2		2.2
92			2.9						2.4		2.6	2.1		2.2
94									2.3			2.0		
96									2.1			1.7		

65201

# 主寸法

# LTM 1400NX

## 外観寸法

単位：mm

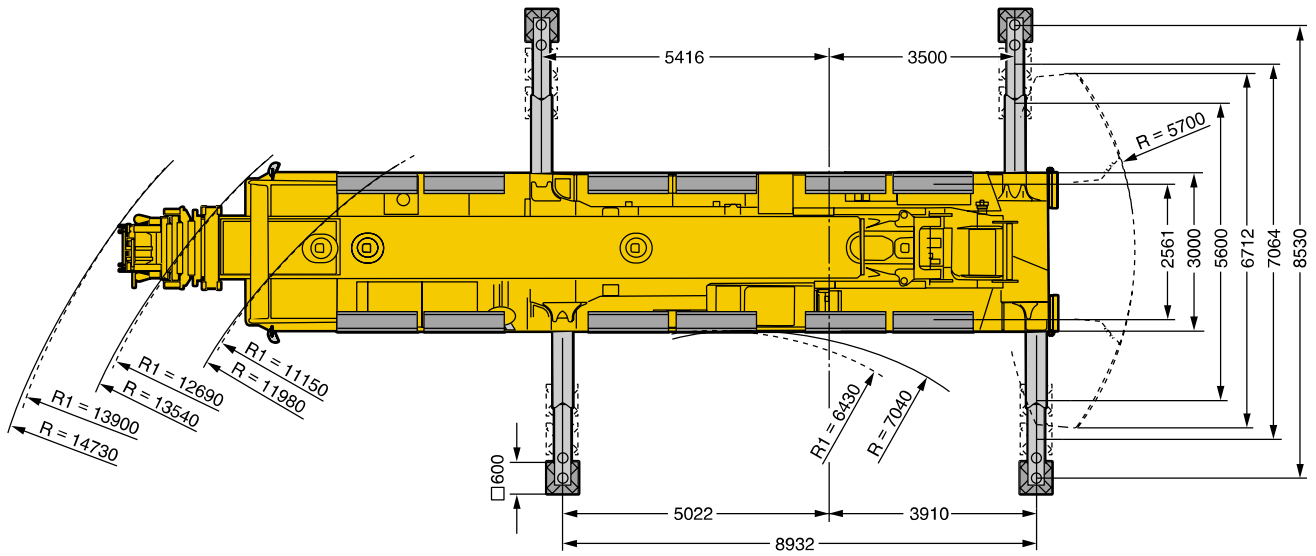
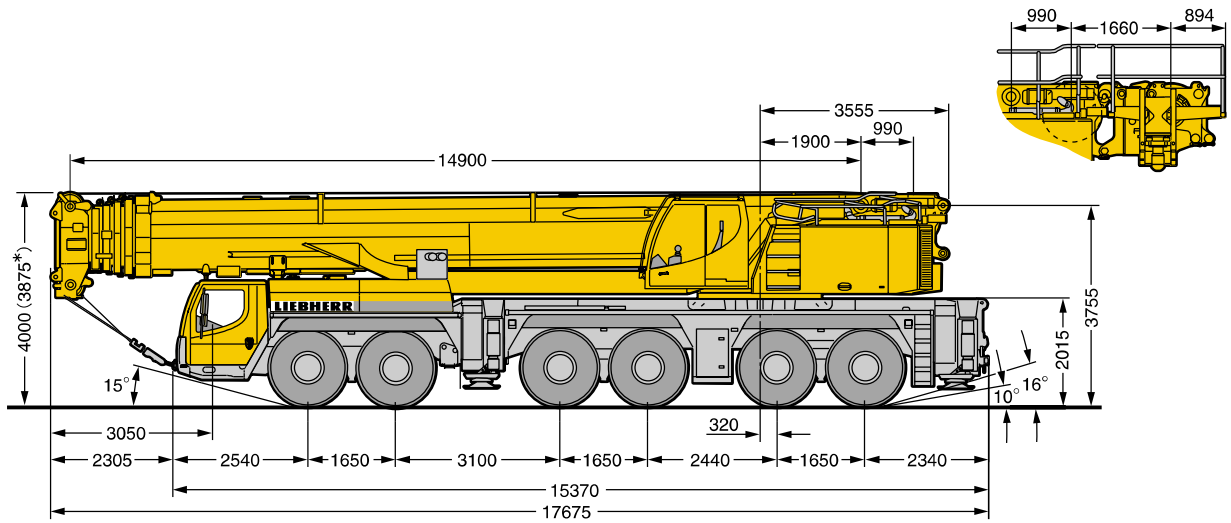

\*サスペンションを125mm下げた状態  
R1 = 全輪ステアリング時